



Universal Motorized Projector Lift (APL-150T)



Features

- ◇ Height Adjustable
- ◇ Standard Tubular Motor
- ◇ RF Remote
- ◇ Heavy Duty
- ◇ Easy Installation
- ◇ Elegant Appearance & Low Noise
- ◇ White

Specification:

- Maximum Running Distance : 1.5Mtr
- Power: 230V (+-10%), 50/60Hz, 115W
- Plug : 3 Pin UK Style
- Control Method : Remote & Manual Switch
- Load Capacity: 25kg/55lbs

Technical Parameters:

- ❖ Ceiling Mount Panel Size: 305*280mm (W*L) [A*B]
- ❖ Electric Hanger: 120mm [C]
- ❖ Lift Size : 1.5Mtr [H]
- ❖ Connecting Lead Screw Length: 290mm [D]
- ❖ Decorate Panel Outer Size: 490*490mm [W*W]
- ❖ Decorate Panel inner Size: 400*400mm [[W1*W1]
- ❖ Close Size: 490*490*550mm (L*W*H)

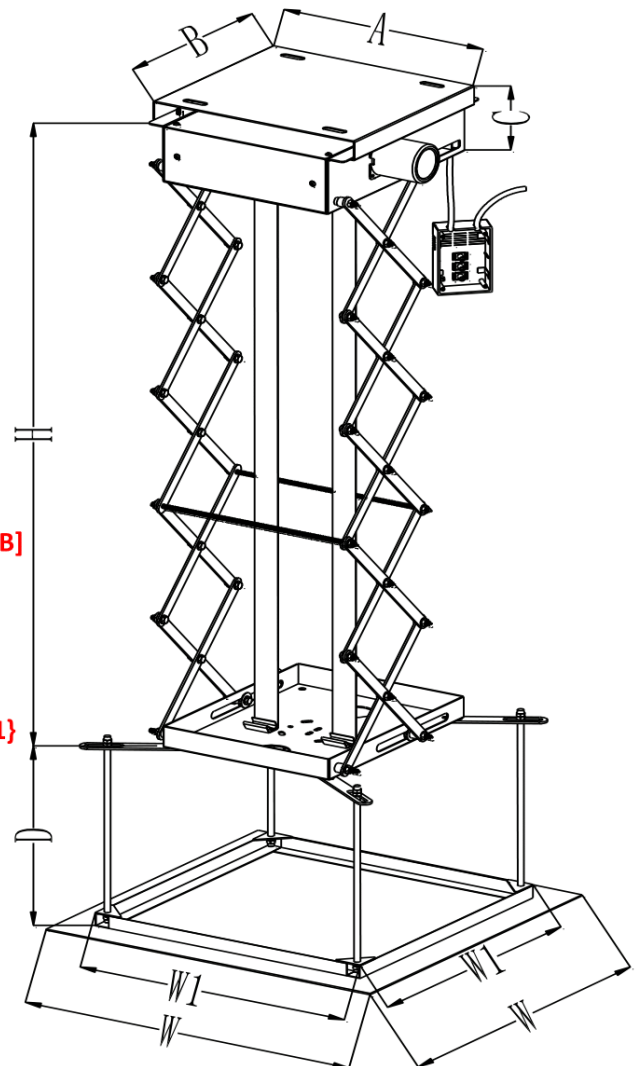



Universal Motorized Projector Lift (APL-150T)

INSTALLATION DEMONSTRATION

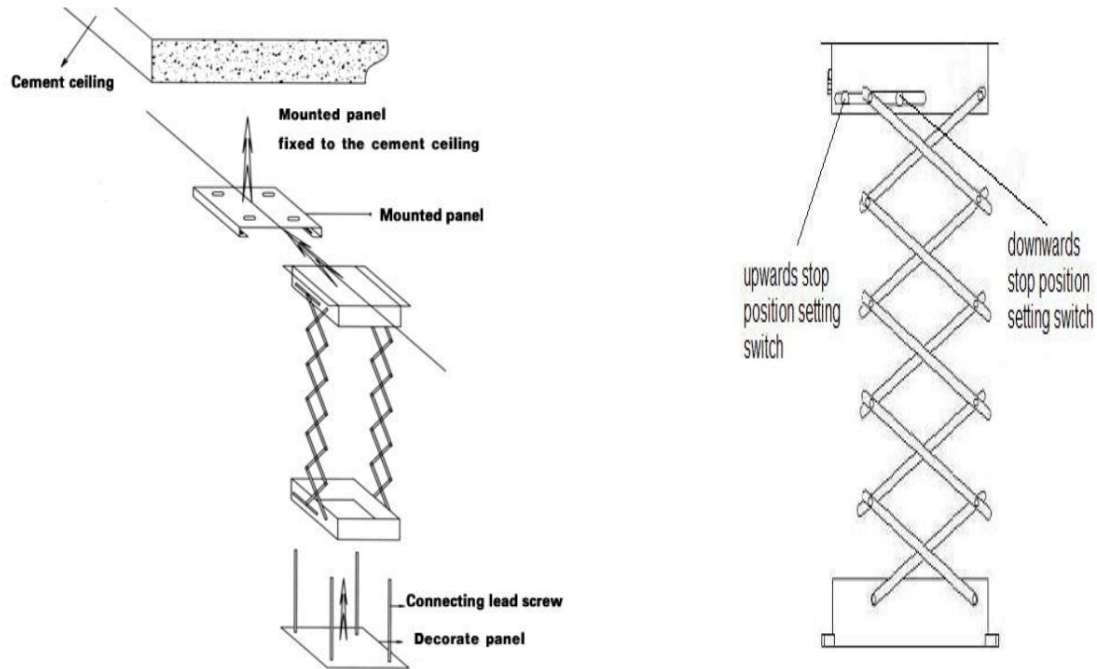

Packing:

Gross Weight: 21.2Kg/Net Weight: 20kg

Dimension: 53*53*34cm

Country of Origin: People's Republic of China

Note: We provide one year warranty for any manufacturing defects of our Electric Projector Lift.