



# Smart Hospitality Display

## HAU8000 Series (NA)

43 50 55 65 75

### HIGHLIGHTS

- Enhance content with 4K UHD Crystal Display for perfect picture quality
- Slim design that complements any interior while saving space
- Centralized management of hotel displays worldwide
- Optimize promotions and offers using personalized guest insights
- Customize content and empower system integrators to build web applications

### Key features



#### Lifelike color, in its purest state with fine crystal

Elevate your hotel's entertainment experiences with Dynamic Crystal Color. With a billion shades of color, every subtlety can be seen from the comfort of the hotel room.

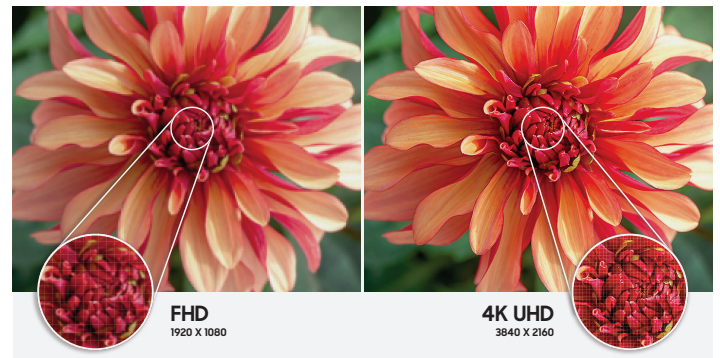

#### Feel the reality of 4K UHD Resolution

Offer guests the vivid picture quality of home entertainment systems, using upscaling technology to display content in UHD resolution (3,840 X2,160), four times the pixels of standard FHD.



#### Sleek and slim, more than ever

Increase flexibility with ultra-slim design, enabling hotel operators to create optimized room layouts that increase guest comfort.



#### The richer sounds of synergy between TV and soundbar

By seamlessly synchronizing the Samsung TV and soundbar, this powerful combination delivers sound simultaneously from both devices without any complicated setup.

# HAU8000 Hospitality Solution

## LYNK Cloud



### Streamlined property management

With online access that supports multiple users, Samsung LYNK Cloud is ideal for global hospitality operations with centralized management, giving users control of their hotel displays worldwide.

\* LYNK Cloud does not support management of properties within China.

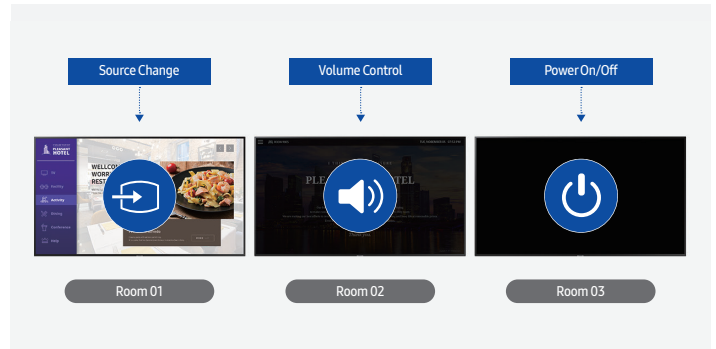

### Integrated device management

Quickly update in-room TVs from a centralized source with Samsung LYNK Cloud. Managers can modify channel maps and program guides and control basic functions, making it easier than ever to provide support and maintenance.

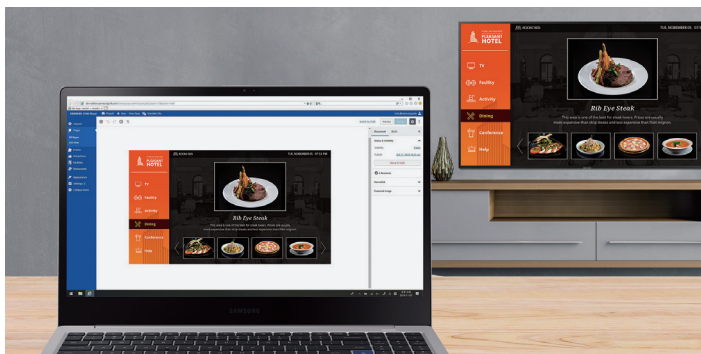

### Content creation and custom interactions

Curate your hotel's in-room experience with LYNK Cloud. Create and remotely deploy web-based content to each in-room TV for a tailored feel to your property. With interactive requests support, you can provide the easiest way for guests to make room service orders and book spa appointments.

\* Some features may not be compatible with hotel's current platforms.

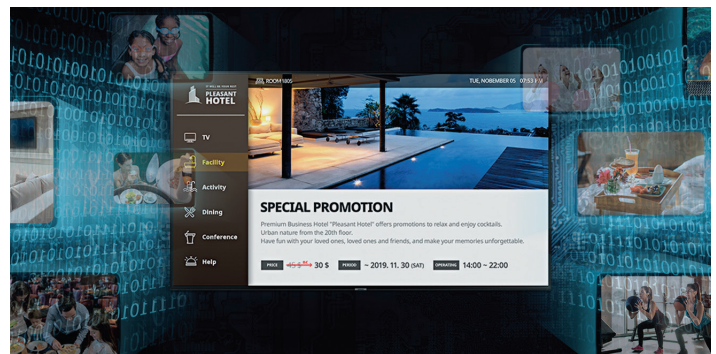

### Data-driven promotional planning

Samsung LYNK Cloud enables optimized promotional content delivery based on integrated guest data available through the hotel PMS, helping managers to uncover business insights.

## H.Browser



### Simple, compatible web app development

Create greater content development flexibility. H.Browser provides superior in-room entertainment and enables system integrators to develop smarter hospitality solutions. Apps stored in TIZEN OS are supported by Web Simulator and Remote Web Inspector tools to refine performance and security.

## Home App

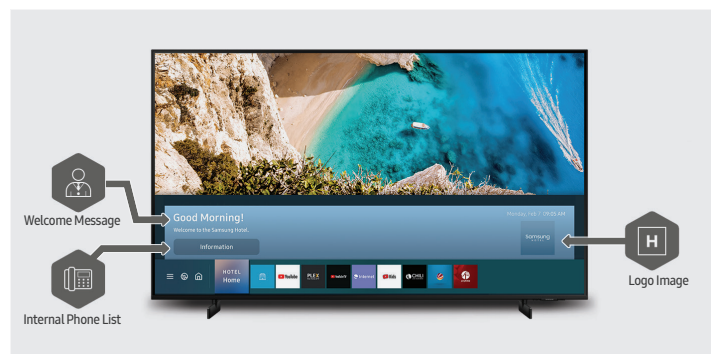

### Easier, Faster control with Home App and Eden UI

Incorporate welcome messages, add logos/branding and provide other useful information such as phone extensions to various guest services. Display on the Eden user interface is a sleek, fast and simple solution.

\* Available apps may vary by region.

# Specifications

Model		43"	50"	55"	65"	75"
Display	Product	LED	LED	LED	LED	LED
	Resolution	3,840 x 2,160	3,840 x 2,160	3,840 x 2,160	3,840 x 2,160	3,840 x 2,160
	Picture Engine	Crystal Processor 4K	Crystal Processor 4K	Crystal Processor 4K	Crystal Processor 4K	Crystal Processor 4K
	Micro Dimming	UHD Dimming	UHD Dimming	UHD Dimming	UHD Dimming	UHD Dimming
	Auto Motion Plus	Yes	Yes	Yes	Yes	Yes
	LED Clear Motion	Clear Motion	Clear Motion	Clear Motion	Clear Motion	Clear Motion
	Film Mode	Yes	Yes	Yes	Yes	Yes
	PQI (Picture Quality Index)	2200	2200	2200	2200	2200
	HDR(High Dynamic Range)	HDR	HDR	HDR	HDR	HDR
	HDR10+	Support	Support	Support	Support	Support
Video	HLG (Hybrid Log Gamma)	Yes	Yes	Yes	Yes	Yes
	Contrast	Mega Contrast	Mega Contrast	Mega Contrast	Mega Contrast	Mega Contrast
	Color	Dynamic Crystal Color	Dynamic Crystal Color	Dynamic Crystal Color	Dynamic Crystal Color	Dynamic Crystal Color
	Viewing Angle (H/V)	178/178	178/178	178/178	178/178	178/178
	Contrast Enhancer	Yes	Yes	Yes	Yes	Yes
	Dolby Digital Plus	Yes	Yes	Yes	Yes	Yes
	Sound Output (RMS)	20W	20W	20W	20W	20W
	Speaker Type	2CH	2CH	2CH	2CH	2CH
	Bluetooth Audio	Yes	Yes	Yes	Yes	Yes
	Samsung SMART TV	Smart	Smart	Smart	Smart	Smart
Smart TV	TV Plus	Yes	Yes	Yes	Yes	Yes
	Web Browser	Yes	Yes	Yes	Yes	Yes
VESA	VESA Mount	200 x 200 mm	200 x 200 mm	200 x 200 mm	400 x 300 mm	400 x 400 mm
	VESA Screw Size	M8	M8	M8	M8	M8
	VESA Screw Depth	11-13	11-13	11-13	11-13	11-13
	Mobile to TV - Mirroring, DLNA	Yes	Yes	Yes	Yes	Yes
	WiFi Direct	Yes	Yes	Yes	Yes	Yes
	Sound Mirroring	Yes	Yes	Yes	Yes	Yes
	Accessibility	US English	US English	US English	US English	US English
General Feature	Auto Channel Search	Yes	Yes	Yes	Yes	Yes
	Auto Power Off	Yes	Yes	Yes	Yes	Yes
	Caption (Subtitle)	Yes	Yes	Yes	Yes	Yes
	Connect Share™ (HDD)	Yes	Yes	Yes	Yes	Yes
	ConnectShare™ (USB 2.0)	Yes	Yes	Yes	Yes	Yes
	EPG	Yes	Yes	Yes	Yes	Yes
	OSD Language	English, Spanish, French	English, Spanish, French	English, Spanish, French	English, Spanish, French	English, Spanish, French
	BT HID Built-in	Yes	Yes	Yes	Yes	Yes
	USB HID Support	Yes	Yes	Yes	Yes	Yes
	Ambient Mode	Ambient Mode	Ambient Mode	Ambient Mode	Ambient Mode	Ambient Mode
	V-Chip	Yes	Yes	Yes	Yes	Yes
	MBR Support	Yes	Yes	Yes	Yes	Yes
	IPv6 Support	Yes	Yes	Yes	Yes	Yes
System	Digital Broadcasting	ATSC/ClearQAM	ATSC/ClearQAM	ATSC/ClearQAM	ATSC/ClearQAM	ATSC/ClearQAM
	Analog Tuner	Yes	Yes	Yes	Yes	Yes
Hospitality Feature	H.Browser Compatibility	Yes	Yes	Yes	Yes	Yes
	Samsung LYNK™ Cloud	Yes	Yes	Yes	Yes	Yes
	Hospitality Home Menu 2.0	Yes	Yes	Yes	Yes	Yes
	Hospitality Plug&Play (Easy Set-up)	Yes	Yes	Yes	Yes	Yes
	Power On Mode	Yes	Yes	Yes	Yes	Yes
	Hotel Channel List	Yes	Yes	Yes	Yes	Yes
	Channel Menu Display	Yes	Yes	Yes	Yes	Yes
	Mixed Channel List (ATSC, DVB-1/2/C/S2, Analog)	Yes	Yes	Yes	Yes	Yes
	My Channel	Yes	Yes	Yes	Yes	Yes
	Energy Saving Mode (BLU Control)	Yes	Yes	Yes	Yes	Yes
	RJ12/IR Pass Through	Yes	Yes	Yes	Yes	Yes
	Clock Back Up Supply	Yes	Yes	Yes	Yes	Yes
	USB Cloning	Yes	Yes	Yes	Yes	Yes
	Wake-up Timer (Alarm)	Yes	Yes	Yes	Yes	Yes
	Samsung LYNK™ DRM	Yes	Yes	Yes	Yes	Yes
	Pro:Idiom SW	Yes	Yes	Yes	Yes	Yes
	Security Mode	Yes	Yes	Yes	Yes	Yes
Input & Output	USB	2	2	2	2	2
	Ethernet (LAN)	Yes	Yes	Yes	Yes	Yes
	Digital Audio Out (Optical)	1	1	1	1	1
	RF In (Terrestrial / Cable input / Satellite Input)	1/1(Common Use for Terrestrial)/0	1/1(Common Use for Terrestrial)/0	1/1(Common Use for Terrestrial)/0	1/1(Common Use for Terrestrial)/0	1/1(Common Use for Terrestrial)/0
	Ex-Link (Supports RS-232C Gender)	Supports Stereo Jack to RS232 Adapter	Supports Stereo Jack to RS232 Adapter	Supports Stereo Jack to RS232 Adapter	Supports Stereo Jack to RS232 Adapter	Supports Stereo Jack to RS232 Adapter
	HDMI A / Return Ch. Support	Yes	Yes	Yes	Yes	Yes
	WiFi	Yes (WiFi5)	Yes (WiFi5)	Yes (WiFi5)	Yes (WiFi5)	Yes (WiFi5)
	Anynet+ (HDMI-CEC)	Yes	Yes	Yes	Yes	Yes
	Variable Audio Out	Yes	Yes	Yes	Yes	Yes
	Variable Audio Out Volume Control	Yes	Yes	Yes	Yes	Yes
Design	RJ12	Yes	Yes	Yes	Yes	Yes
	Ethernet Bridge (LAN-Out)	Yes	Yes	Yes	Yes	Yes
	Front Color	BLACK	BLACK	BLACK	BLACK	BLACK
Eco	Stand Type	FLAT LIFT	FLAT LIFT	FLAT LIFT	FLAT LIFT	FLAT LIFT
	Bezel Type	3 Bezel-less	3 Bezel-less	3 Bezel-less	3 Bezel-less	3 Bezel-less
Power	Eco Sensor	Yes	Yes	Yes	Yes	Yes
	Power Supply (V)	AC110-120V 50/60Hz	AC110-120V 50/60Hz	AC110-120V 50/60Hz	AC110-120V 50/60Hz	AC110-120V 50/60Hz
	Power Consumption (Max)	120 W	130 W	150 W	205 W	260 W
	Power Consumption (Stand-by)	0.5 W	0.5 W	0.5 W	0.5 W	0.5 W
Dimension	Power Consumption (Typical)	56 W	72 W	75 W	93 W	122 W
	Set Dimension without Stand (WxHxD)	965.5 x 559.9 x 25.7 mm	1118.3 x 644.6 x 25.7 mm	1232.1 x 708.8 x 25.7 mm	1450.9 x 831.9 x 25.7 mm	1676.7 x 960.3 x 26.6 mm
	Set Dimension with Stand (WxHxD)	695.5 x 600.1 x 195.1 mm	1118.3 x 684.6 x 226.3 mm	1232.1 x 748.8 x 226.3 mm	1450.9 x 874.3 x 279.4 mm	1676.7 x 1003.4 x 331.9 mm
Weight	Package Dimension (WxHxD)	1093 x 677 x 129 mm	1246 x 771 x 137 mm	1399 x 846 x 148 mm	1612 x 950 x 164 mm	1834 x 1110 x 190 mm
	Set Weight without Stand	8.4 kg	11.5 kg	15.5 kg	20.9 kg	31.4 kg
	Set Weight with Stand	8.7 kg	11.8 kg	15.8 kg	21.4 kg	32 kg
Accessory	Package Weight	11.9 kg	16 kg	22 kg	28.4 kg	42.3 kg
	Remote Controller Model	TM1640A	TM1640A	TM1640A	TM1640A	TM1640A
	Batteries (for Remote Control)	Yes	Yes	Yes	Yes	Yes
	Mini Wall Mount Supported	Yes	Yes	Yes	Yes	N/A
	VESA Wall Mount Supported	Yes	Yes	Yes	Yes	Yes
	Power Cable	Yes	Yes	Yes	Yes	Yes
	Quick Install Guide	Yes	Yes	Yes	Yes	Yes
	Data Cable	Yes	Yes	Yes	Yes	Yes
Optional Stand Support (Studio)	N/A	Yes	Yes	Yes	N/A	

# Technical drawings

43"

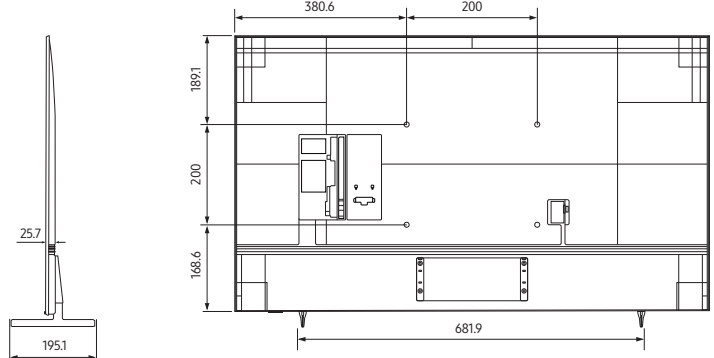
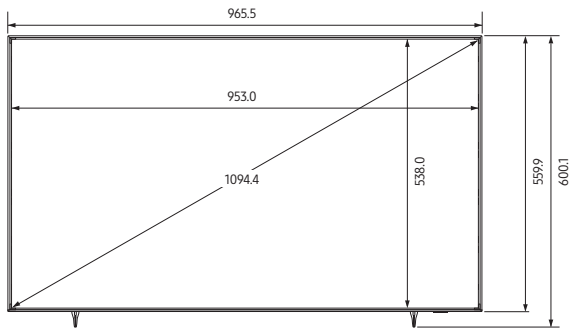

50"

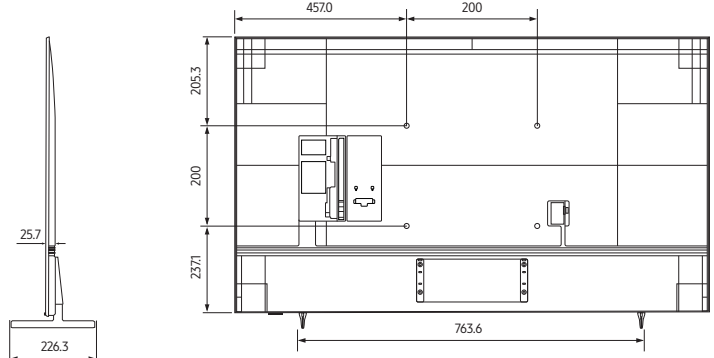
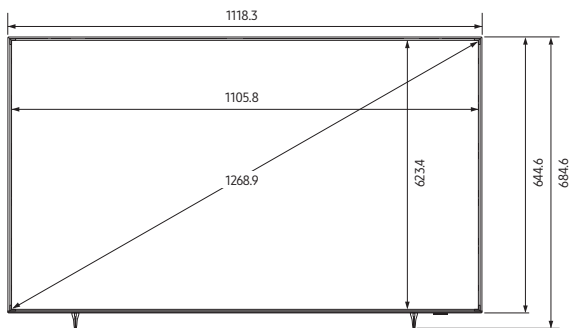

55"

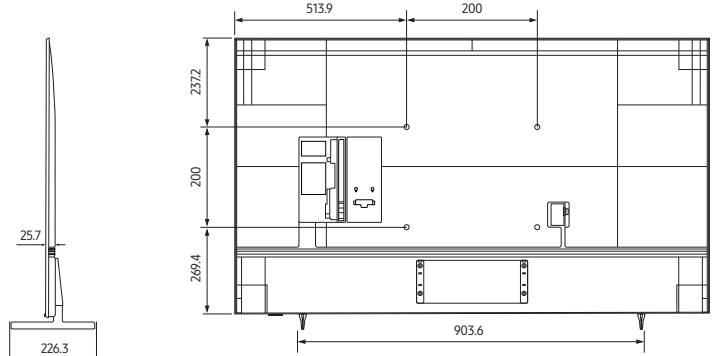
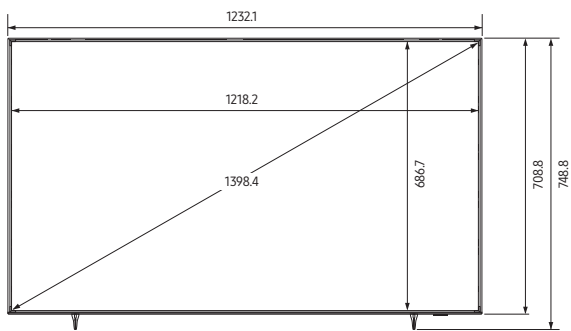

65"

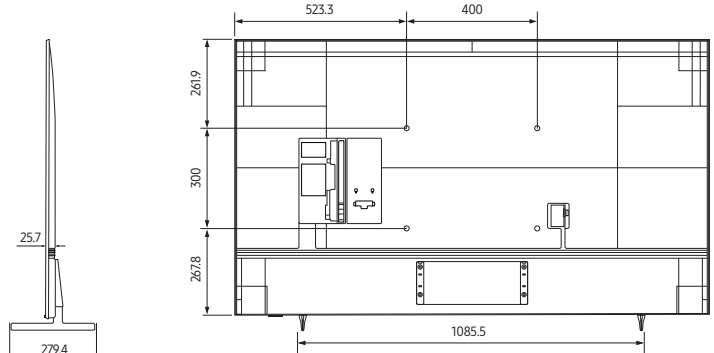
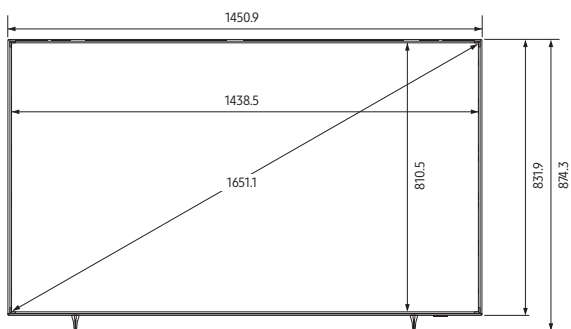

## Technical drawings

75"

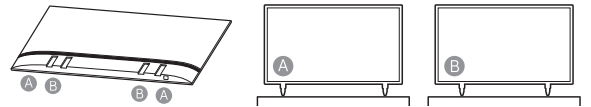
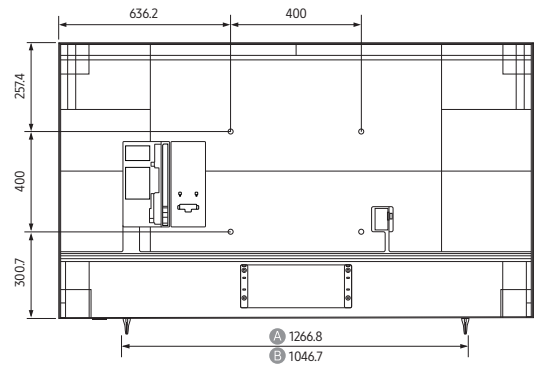
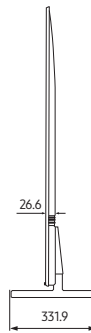
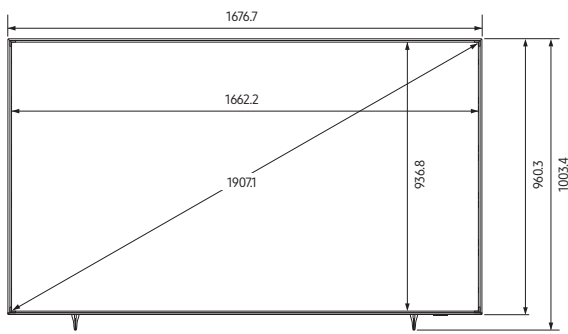

\* There are two options for the 75" stand.  
Customer can choose one of the two according to the situation.

## Connectors

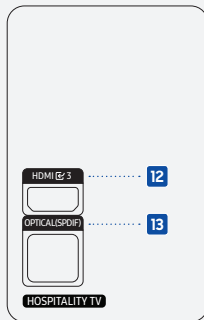
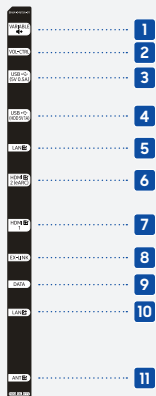

- |                         |                           |                           |
|-------------------------|---------------------------|---------------------------|
| <b>1</b> VARIABLE       | <b>6</b> HDMI IN 2 (eARC) | <b>11</b> ANT IN          |
| <b>2</b> VOL-CTRL       | <b>7</b> HDMI IN 1        | <b>12</b> HDMI IN 3       |
| <b>3</b> USB (5V 0.5A)  | <b>8</b> EX-LINK          | <b>13</b> OPTICAL (SPDIF) |
| <b>4</b> USB (HDD 5V1A) | <b>9</b> DATA             |                           |
| <b>5</b> LAN IN         | <b>10</b> LAN OUT         |                           |

### About Samsung Electronics Co., Ltd.

Samsung Electronics Co., Ltd. inspires the world and shapes the future with transformative ideas and technologies. The company is redefining the worlds of TVs, smartphones, wearable devices, tablets, cameras, digital appliances, medical equipment, network systems, and semiconductor and LED solutions. For the latest news, please visit the Samsung Newsroom at [news.samsung.com](http://news.samsung.com).

### Hospitality Display

For more information about Samsung Hospitality Displays, visit [www.samsung.com/business](http://www.samsung.com/business) or [www.samsung.com/displaysolutions](http://www.samsung.com/displaysolutions)

Copyright © 2021 Samsung Electronics Co. Ltd. All rights reserved. Samsung is a registered trademark of Samsung Electronics Co. Ltd. Specifications and designs are subject to change without notice. Non-metric weights and measurements are approximate. All data were deemed correct at time of creation. Samsung is not liable for errors or omissions. All brand, product, service names and logos are trademarks and/or registered trademarks of their respective owners and are hereby recognized and acknowledged.

Samsung Electronics Co., Ltd.  
416, Maetan 3-dong, Yeongtong-gu, Suwon-si, Gyeonggi-do 443-772, Korea