



# SE846

## Sound Isolating™ Earphones

The Shure sound isolating earphones, SE846, user guide.  
Version: 1.0 (2022-I)

# Table of Contents

<b>SE846 Sound Isolating™ Earphones</b>	<b>3</b>	<b>Cleaning the Nozzle</b>	<b>6</b>
<b>Important Safety Information</b>	<b>3</b>	<b>Four Interchangeable Nozzle Inserts</b>	<b>6</b>
<b>Sound Isolating™ Earphones</b>	<b>3</b>	Removing the Nozzle	6
<b>Using Earphones</b>	<b>3</b>	Reassembling the Nozzle	7
The best sound starts with a good fit	3	<b>Specifications</b>	<b>7</b>
Changing Sleeves	4	<b>SAFETY PRECAUTIONS</b>	<b>8</b>
<b>Wearing the Earphones</b>	<b>4</b>	WARNING FOR ALL EARPHONES!	8
<b>Removing the Earphones</b>	<b>5</b>	SAFETY PRECAUTIONS	8
<b>Detachable Cable</b>	<b>5</b>	WARNING	8
<b>Maintenance and Cleaning</b>	<b>6</b>	CAUTION	9
		IMPORTANT SAFETY INSTRUCTIONS	9
		<b>Certifications</b>	<b>9</b>

---

## SE846 Sound Isolating™ Earphones

---

### Important Safety Information

Before using this product, please read the warnings and safety instructions: [SAFETY PRECAUTIONS](#)

---

## Sound Isolating™ Earphones

Shure Sound Isolating™ Earphones, built with balanced armature speakers, deliver a detailed soundstage free from outside noise. The powerful and stylish Shure SE earphones come with a detachable cable, adapters, a durable carrying case, and interchangeable Sound Isolating sleeves for a comfortable and personalized fit.

---

### Using Earphones

The best sound starts with a good fit

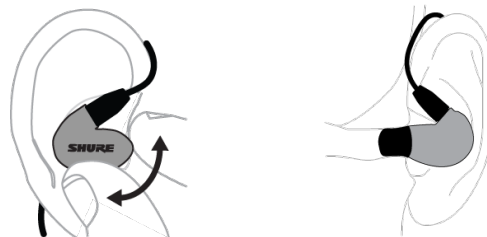

- Select the sleeve that provides a snug fit (like earplugs).
- Secure the cable behind the ear to maintain a tight seal.

## Changing Sleeves

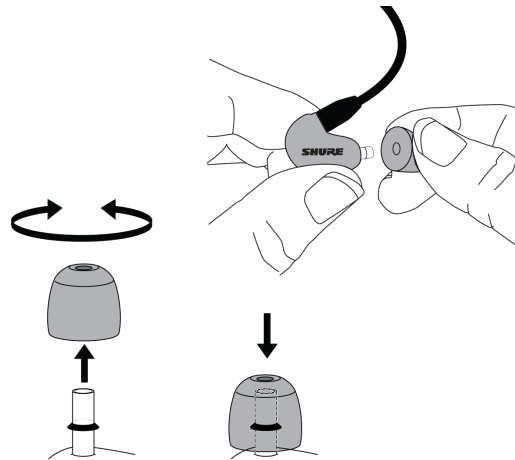

- Gently twist and pull to remove sleeve.
- Install the new sleeve so it completely covers the barb and nozzle.

Visit <http://www.shure.com/earphones> for replacement parts and important instructions on cleaning and maintenance.

## Wearing the Earphones

Wear them like earplugs. A good acoustic seal provides maximum bass.

1. Select a sleeve.
2. Twist and pull to remove. Push new sleeve on fully. Compress foam sleeve slightly.
3. Insert firmly into ear. Wear cable over and behind ear. Tighten the cable and take up slack by raising the cable cinch.

**Important:** If there seems to be a lack of low frequency response (bass), this means that the earphone sleeve is not forming a tight seal. Gently push the earphone deeper into the ear canal or try a different sleeve.

**Warning:** Do not push the earphone sleeve beyond the ear canal opening.

Wearing the cable over the ear and securing it behind the head can help keep the earphones in place during physical activity.

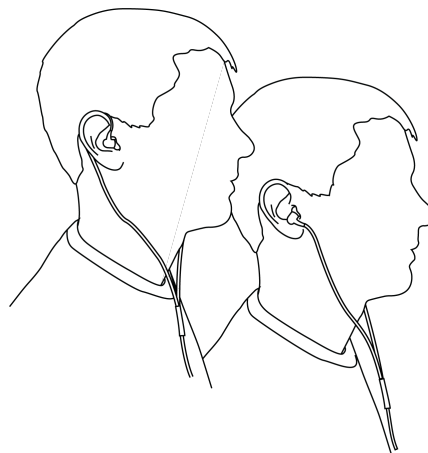

## Removing the Earphones

Grasp the body of earphone and gently twist to remove.



**Note:** Do not pull on cable to remove earphone.

## Detachable Cable

You may need to detach the cable from the earphones to attach optional components or to replace the cable if it becomes damaged. To prevent accidental separation, the connector has a snug fit. Take special care to prevent damage to the earphone and connector.

- Do not use pliers or other tools.
- Grasp the connector and the earphone as close as possible to where they join.
- Pull straight apart—do not twist. Cable is a snap fit, not threaded.

**Note:** If you pull at an angle, the connector will not detach.

- Do not pull on the cable or put any pressure on the earphone nozzle.
- Listen for a click when connecting.
- When reattaching the cable, match the "L" and "R" markings. For clear cables and earphones, match the color dots (Red=Right, Blue=Left).

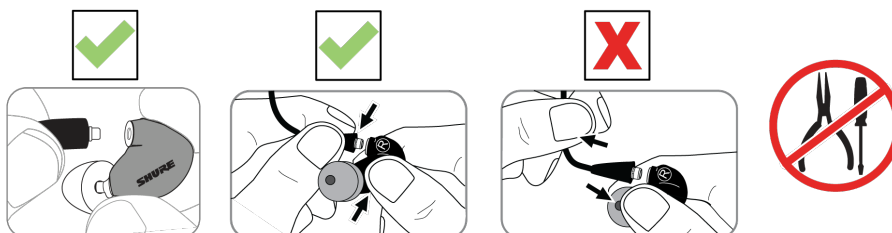

Audible click when properly connected

## Maintenance and Cleaning

Careful maintenance ensures a tight seal between the sleeve and nozzle, improving sound quality and product safety.

- Keep the earphones and sleeves as clean and dry as possible.
- To clean sleeves, remove them from earphones, gently rinse in warm water and air dry. Foam sleeves require a longer drying time. Inspect for damage and replace if necessary. Ear sleeves must be completely dry before reusing.
- Wipe the earphones and sleeves with mild antiseptic to avoid infections. Do not use alcohol-based disinfectants.
- Do not expose earphones to extreme temperatures.
- Replace sleeves if they do not fit properly.
- Do not attempt to modify this product. Doing so will void the warranty and could result in personal injury and/or product failure.

## Cleaning the Nozzle

If you notice a change in sound quality, remove the sleeve and check the nozzle of your earphone. If nozzle is blocked, clear obstructions.

If no obstruction is found or if sound quality does not improve, replace the sleeve with a new sleeve or disassemble the nozzle to clean inside.

**Caution:** When cleaning, do not force any object through the earphone nozzle! This will damage the earphone sound filter.

## Four Interchangeable Nozzle Inserts

Color	Sound Signature	Response
Black	Warm	-2.5 dB, 1 kHz to 8 kHz
Blue	Balanced	Neutral
Red	Extended (as shipped)	+2.0 dB, 4kHz to 10kHz
White	Bright	+2.5 dB, 1 kHz to 8 kHz

## Removing the Nozzle

### Note:

- SMALL PARTS! Choose a proper work surface.
  - Use only your fingers to manipulate parts.
  - Do not use tools (or teeth), as this causes damage.
1. Use the included *nozzle key* to loosen and remove the threaded collar.
  2. Pull gently on the *nozzle* to remove.
  3. Grasp the end of the *nozzle insert* and gently slide it out.

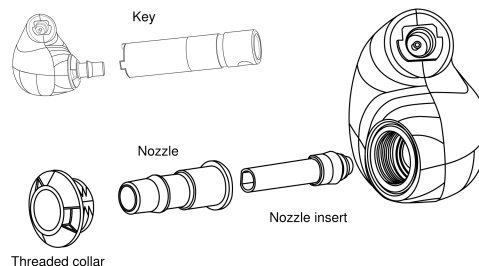

## Reassembling the Nozzle

### Caution:

- **Do not force parts.** Reposition as necessary to assure a smooth and easy fit.
- The *nozzle insert* must be properly seated in the nozzle.
- The *nozzle* must be aligned to fit the keyed opening in the housing (dots aligned).
- Ensure the threads are properly engaged before using the nozzle key.
- Tighten the threaded collar just enough to ensure it will not loosen during normal earphone usage.

1. Place the *nozzle insert* into the *nozzle* before inserting it into the earphone.
2. Align the dots to match the *nozzle* to the keyed opening.
3. Turn the *threaded collar* all the way into the earphone housing using the *nozzle key*.

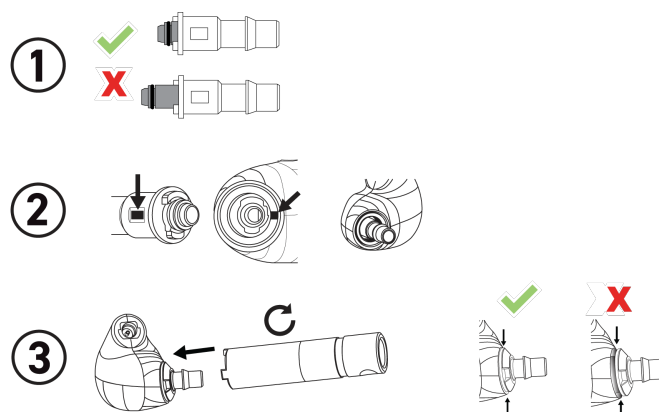

## Specifications

### Transducer Type

Quad balanced-armature drivers

### Sensitivity

at 1 kHz

114 dB SPL/mW

### Impedance

at 1 kHz

9 Ω

Noise Attenuation  
up to 37 dB

Frequency Range  
15 Hz–20 kHz

Input Connector  
MMCX connectors

Net Weight  
27.6 g (.9 oz.)

Operating Temperature  
0°C to 45°C (32°F to 113°F)

Storage Temperature  
-10°C to 35°C (14°F to 95°F)

## SAFETY PRECAUTIONS



Before using this product, please read and save the enclosed warnings and safety instructions.

### WARNING FOR ALL EARPHONES!

Use, clean, and maintain earphones according to manufacturer's instructions.

### SAFETY PRECAUTIONS

The possible results of incorrect use are marked by one of the two symbols—"WARNING" and "CAUTION"—depending on the imminence of the danger and the severity of the damage.

	WARNING: Ignoring these warnings may cause severe injury or death as a result of incorrect operation.
	CAUTION: Ignoring these cautions may cause moderate injury or property damage as a result of incorrect operation.

### WARNING

- If water or other foreign objects enter the inside of the device, fire or electric shock may result.
- Do not attempt to modify this product. Doing so could result in personal injury and/or product failure.
- Do not use when a failure to hear your surroundings could be dangerous, such as while driving, or when biking, walking, or jogging where traffic is present and accidents could occur.
- Keep this product and its accessories out of reach of children. Handling or use by children may pose a risk of death or serious injury. Contains small parts and cords that may pose risk of choking or strangulation.



- Prior to inserting the earphone, always recheck the sleeve to make sure it is firmly attached to the nozzle to decrease the risk of sleeves detaching from the nozzle and becoming lodged in your ear. If a sleeve becomes lodged in your ear, seek professional medical assistance to remove the sleeve.
- Stop using the earphones and consult a medical professional if you experience irritation, excessive wax buildup, or other discomfort.

## CAUTION

- Never disassemble or modify the device, as failures may result.
- Do not subject to extreme force and do not pull on the cable or failures may result.
- Keep the earphone dry and avoid exposure to extreme temperatures and humidity.
- If you are currently receiving ear treatment, consult your physician before using this device.



High sound pressure

Hearing damage risk

To prevent possible hearing damage, do not listen at high volume levels for long periods.

## IMPORTANT SAFETY INSTRUCTIONS

1. READ these instructions.
2. KEEP these instructions.
3. HEED all warnings.
4. FOLLOW all instructions.
5. DO NOT use this apparatus near water.
6. CLEAN ONLY with dry cloth.
7. DO NOT block any ventilation openings. Install in accordance with the manufacturer's instructions.
8. DO NOT install near any heat sources such as radiators, heat registers, stoves, or other apparatus (including amplifiers) that produce heat.
9. DO NOT defeat the safety purpose of the polarized or grounding type plug. A polarized plug has two blades with one wider than the other. A grounding type plug has two blades and a third grounding prong. The wider blade or the third prong are provided for your safety. If the provided plug does not fit into your outlet, consult an electrician for replacement of the obsolete outlet.
10. PROTECT the power cord from being walked on or pinched, particularly at plugs, convenience receptacles, and the point where they exit from the apparatus.
11. ONLY USE attachments/accessories specified by the manufacturer.
12. USE only with a cart, stand, tripod, bracket, or table specified by the manufacturer, or sold with the apparatus. When a cart is used, use caution when moving the cart/apparatus combination to avoid injury from tip-over.



13. UNPLUG this apparatus during lightning storms or when unused for long periods of time.

# Certifications

This product meets the Essential Requirements of all relevant European directives and is eligible for CE marking.

The CE Declaration of Conformity can be obtained from: [www.shure.com/europe/compliance](http://www.shure.com/europe/compliance)

Authorized European representative:

Shure Europe GmbH

Global Compliance

Jakob-Dieffenbacher-Str. 12

75031 Eppingen, Germany

Phone: +49-7262-92 49 0

Email: [info@shure.de](mailto:info@shure.de)

[www.shure.com](http://www.shure.com)