

VPL-VW500ES

a breathtaking 4K home cinema experience

4K Home Cinema
projector – more
than 4x the quality
of Full HD



At a glance

- **4K resolution: 4096 x 2160**
- **Dynamic contrast ratio: 200,000:1**
- **Brightness: 1,700 ANSI lumens**
- **Compact and functional design**



Key Features

Shaped by our professional cinema expertise

With decades of experience developing technology for the big screen, we've packed major innovations into the VPL-VW500ES:

Reality Creation our Super Resolution upscaler. Enjoy your existing Full HD Blu-ray™ collection, transformed for an exceptional 4K experience – even in 3D.

Advanced native 4K SXR panels produce an ultra-smooth, native 4K by dramatically reducing the space between pixels.

TRILUMINOS Display technology produces a much broader colour range, reproducing more tones and textures than a standard projector system for greater purity, depth and realism.

Enjoy your favourite movies in astonishing 4K detail

Imagine the fully immersive cinematic quality of 4K in your own home. Our VPL-VW500ES home cinema projector gives you a 4096 x 2160 resolution picture, over four times better than Full HD. It's just like being at the movies.

The exceptionally high dynamic contrast ratio of 200,000:1 with 1,700 ANSI lumens brightness produces stunning detail and rich, faithful colour – even in well-lit rooms.

Get the very best from your 2D and 3D discs

While more and more native 4K material is becoming available, the VPL-VW500ES uses our Reality Creation technology to upscale Full HD content for an incredible 4K experience. This Super Resolution feature means you'll get the very best from your current Blu-ray Disc™ library, with fuller colour, greater clarity and more impact than ever before.

Compact and user-friendly

The VPL-VW500ES is easy to operate, with a variety of control modes so you get the very best picture, whatever you're watching. With a smaller optical engine than our leading 4K projector, the VPL-VW1000ES, its compact design also offers even greater flexibility for installation.

4K native resolution: over 4x better than Full HD

No compromises: the VPL-VW500ES provides 4096 x 2160 4K resolution (the DCI standard in digital cinemas). We used our professional cinema expertise to develop 4K SXRD panels and produce a 4K native picture with no artificial enhancement of pixels. ►

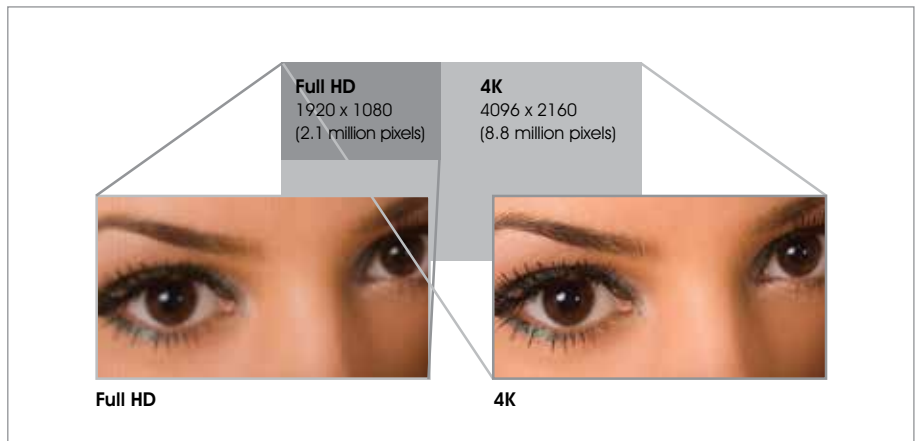

Simulated Images

Ultra high contrast ratio and brightness

Drawing on optical technology developed for the VPL-VW1000ES, we've achieved both high brightness (1,700 ANSI lumens) and high contrast (200,000:1 dynamic contrast ratio) in the VPL-VW500ES. So, you'll see crystal-clear, bright, detail-packed images – even in well-lit rooms.

Advanced SXRD panels

4K digital drive panels minimise the space between pixels in every frame with an incredible response rate of 2.5-milliseconds. That's much faster, and more stable, than an LCD TV and produces ultra-smooth, dot-free pictures with natural, fluid movement – whatever the action. ►

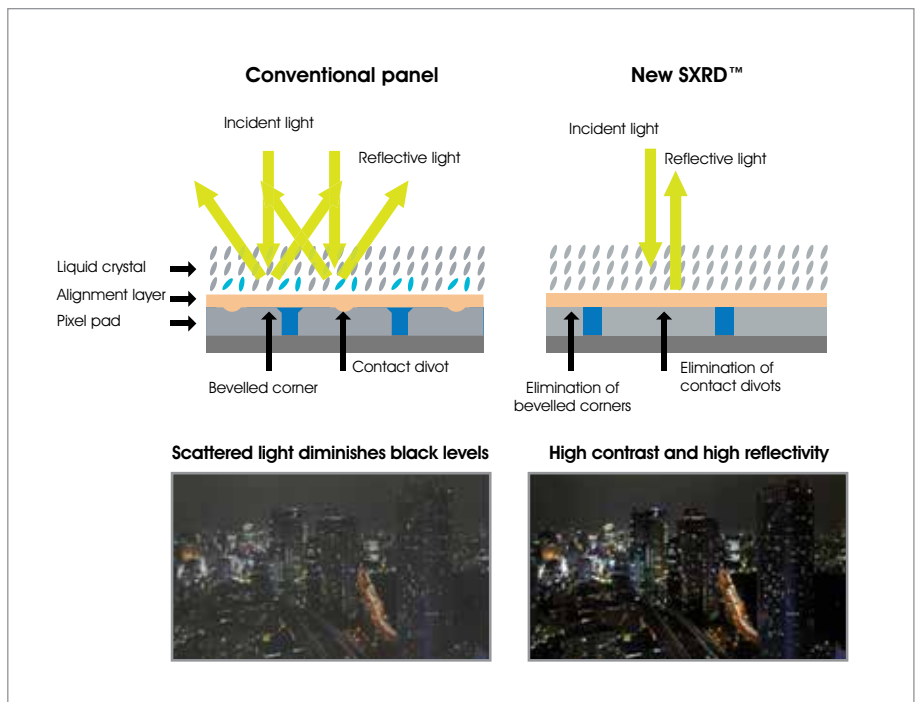

Simulated Images

TRILUMINOS Display

The VPL-VW500's optical engine and SXRD panels incorporate our TRILUMINOS Display technology to produce a much broader colour range, reproducing more tones and textures than a standard projector system. The result is greater purity, depth and realism. ►

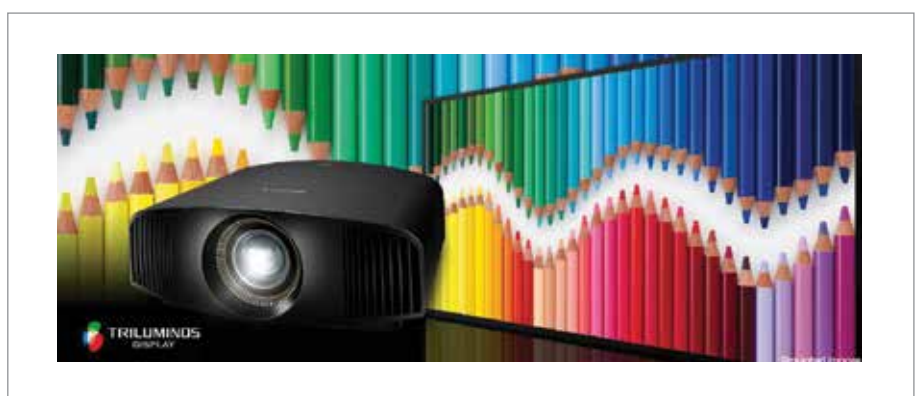

Simulated Images

New Motionflow

We've enhanced our Motionflow technology. 'Combination' mode uses our 'Film Projection' and 'Motion Enhancer', adding frames to reduce blur and maintain brightness in thrilling, fast-moving scenes. Cinema purists can choose 'True Cinema' to retain the original 24 frames per second. ►



Simulated Images

Industry standard RF 3D compatible

A built-in RF transmitter synchronises with any RF 3D glasses for wider coverage, greater stability, and there's no need for an external transmitter. ►

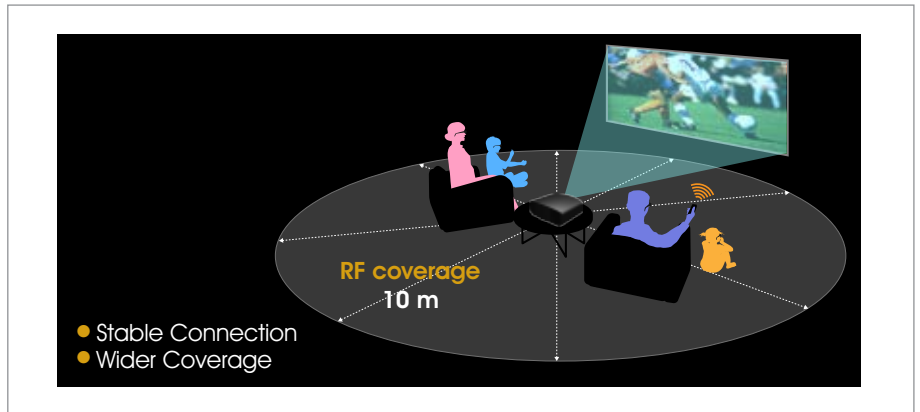

Simulated Images

Reality Creation: upscales your movies to 4K

As well as native 4K material, you can see your current Full HD Blu-ray™ or DVD movie collection upscaled for a 4K experience. Reality Creation is a Super Resolution technology that radically enhances Full HD content, even upscaling 3D movies for 4K. ►

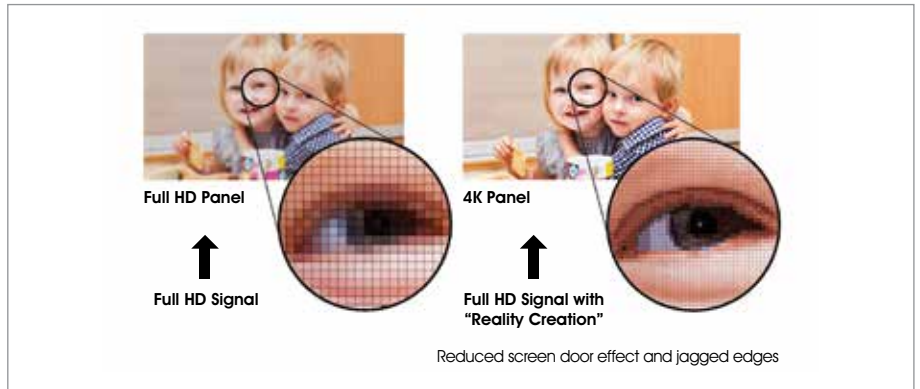

Simulated Images

Compatible with 'Mastered in 4K' Blu-ray™ discs

Drawing on the same technology used to downscale 4K material for Full HD, the VPL-VW500ES gives you a near native 4K experience with discs 'Mastered in 4K'. It's as close as you can get to the 4K-pixel resolution and expanded colour range of the original. ►

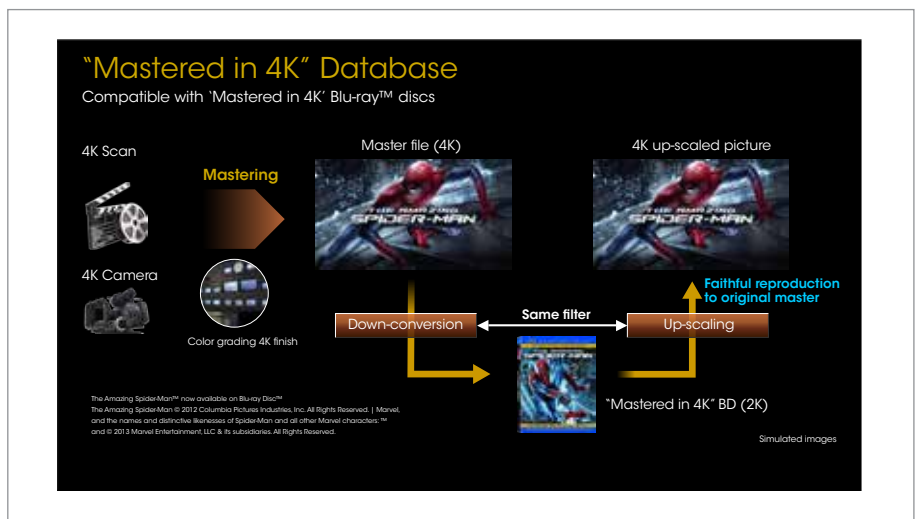

Simulated Images

The latest 4K/60p HDMI standard: 60 frames per second

The VPL-VW500ES can show up to 60 frames per second in 4K (at colour signal YUV 4:2:0 / 8 bit). It's the new 4K industry standard and is much higher than the earlier 24p. The result is a smoother image with superior colour and realism.

Compact design

A smaller optical engine means the VPL-VW500ES is approximately 18cm shorter in length than our leading projector, the VPL-VW1000ES, so there's greater flexibility for installation.

Front-facing fan

Because the fan is positioned at the front, you don't need to worry about wall space and room for air inhale/exhaust when you install. This helps maximize the throw distance for bigger projected images. ▼



Wider zoom and shift lens

A 2.06 motorised zoom lens and wide lens shift range of up to 85% vertical and 31% horizontal gives greater installation flexibility – even when the ceiling is very high.

Auto calibration

After extended periods, colour can be automatically calibrated to the original factory condition. There's no need for extra calibration equipment or cameras; a built-in colour sensor stores all the necessary information. ►

Suitable for home automation

The VPL-VW500ES is compatible with many home automation systems. It has an RS232 interface, RJ45 control, and IR-IN terminal.

Manual HSV Colour Correction

A correction tool allows you to adjust the hue, saturation, and brightness of each colour to get exactly the picture you want.

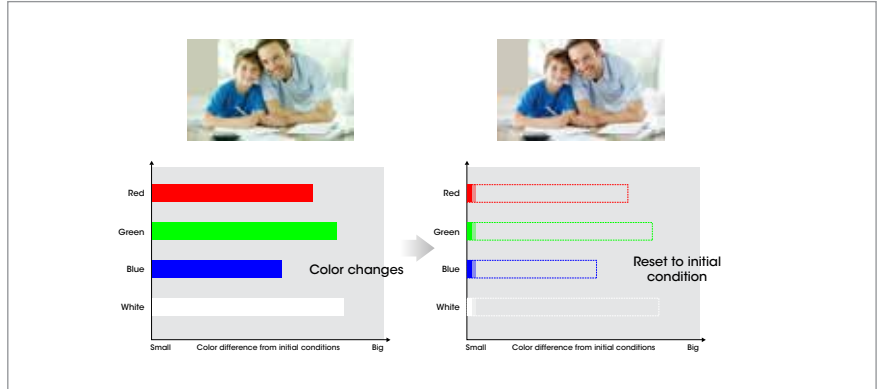

Simulated Images

Picture Position Memory

This feature remembers the position of the zoom lens. You can match it to a movie's aspect ratio (including 16:9 and Cinemascope) and store the settings for a future viewing. ►



Simulated Images

Electronic panel alignment

Ensures the red and blue elements in each pixel are precisely positioned against green. Adjustments can be made by as little as 0.1 pixels for optimum clarity. ►

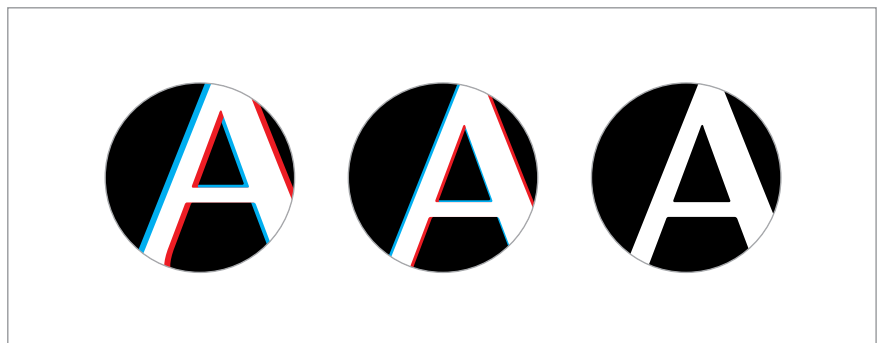

Simulated Images

Wireless option (up to Full HD 60p)

Free yourself from cables and keep things tidy with an optional wireless HDMI emitter/ receiver kit. The VPL-VW500ES can wirelessly connect to your games console, Blu-ray™ Disc player and more, and upscales for a 4K experience with Reality Creation.

USB updates

To get the best from your projector, the VPL-VW500ES has a USB port for the latest firmware updates.

PrimeSupport

The VPL-WW500ES includes our 3-year PrimeSupport package at no extra cost as well as 1-year (or 1,000 hours) lamp cover. Should you experience a problem, there are no unexpected costs: simply call our free, multi-lingual helpline for fast, professional technical support. If we think a repair will take more than 10 days, we'll supply a loan projector.

Prime
Support

Prime
Support Plus

Specifications



		VPL-WW500ES
Display system		High Frame Rate SXRD panel
Light Output		1700 lm
Contrast ratio		200,000:1 (Dynamic Contrast)
Display elements	Effective display size	0.74" x 3
	Effective pixels	4K (4096 x 2160) x3 / 26,542,080 pixels
Projection lens	Zoom / Focus	Electric (Approx. 2.06 x) / Electric
	Lens shift	Electric, V +85% / -80% H: +/-31%
Light source		Ultra High-pressure lamp 265W type
Screen size		60" to 300"
Reality Creation		YES (4K Reality Creation)
Compatible with "Mastered in 4K " Blu-ray		YES
4K 60P (YUV) 4:2:0 / 8 bit		YES
X.V colour		YES
3D capability		YES
3D emitter		Built-in RF emitter
3D glasses		TDG-BT500A (Optional)
Auto Calibration		YES
Manual Calibration		HSV Colour Correction
Picture Position Memory		YES
Wireless HDMI compatibility		IFU-WH1 (Optional)
Advanced Iris		Ver 3
Picture modes		9 modes
Gamma modes		11 modes
Panel Alignment		Yes (Shift / Zone)
Input/Output	HDMI (2 inputs)	Digital RGB/Y Pb/Cb Pr/Cr
	Remote	RS-232C
	LAN	RJ45, 10BASE-T/100BASE-TX
	IR IN	Mini Jack
	TRIGGER	Minijack, DC 12V Max. 100m A
USB		DC 5V. MAX. 500mA
Acoustic noise		26dB
Power requirement		AC 100 V to 240 V, 3.0 A to 1.3 A, 50/60 Hz
Power consumption		Max. 375 W
Body Colour		Black
Standard outside dimensions		W 495.6 x H 195.3 x D 463.6 mm
Weight		Approx. 14 kg
Supplied Accessories		Remote Control RM-PJ24
		Size AA (R6) manganese batteries (2)
		AC Power Cord for projector (1)
		Quick reference manual (1)
		Operating Instructions (CD-ROM) (1)

Optional Accessories

Projector lamp
(LMP-H260)



Wireless HD Unit
(IFU-WH1)



3D Glass
(TDG-BT500A)



Dimensions

Front

Unit: mm

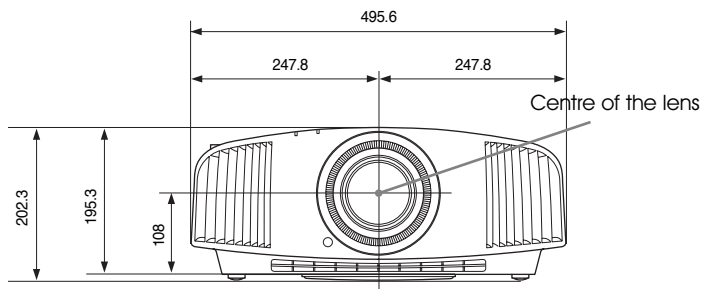

Bottom

Unit: mm

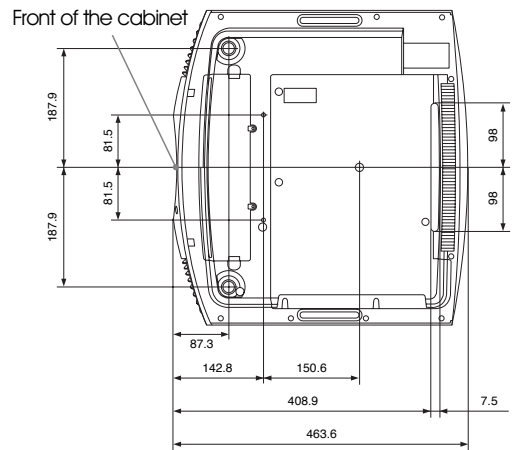

For further details of how to get a fully immersive 4K cinematic experience for your home visit:
www.pro.sony.eu/homecinemaprojectors

© 2013 Sony Corporation. All rights reserved. Reproduction in whole or in part without permission is prohibited. Features and specifications are subject to change without notice. All non-metric weights and measurements are approximate. Sony and make.believe are trademarks of Sony Corporation. All other trademarks are the property of their respective owners.

Distributed by

Professional Solutions Europe is the leading supplier of AV/IT solutions to businesses across a wide variety of sectors including, **Media and Broadcast, Video Security and Retail, Transport & Large Venue markets**. It delivers products, systems and applications to enable the creation, manipulation and distribution of digital audio-visual content that add value to businesses and their customers. With over 25 years' experience in delivering innovative market-leading products, **Professional Solutions Europe** is ideally placed to deliver exceptional quality and value to its customers. **Sony's Professional Services** division, its systems integration arm, offers its customers access to the expertise and local knowledge of skilled professionals across Europe. Collaborating with a network of established technology partners, Professional Solutions Europe delivers end to end solutions that address the customer's needs, integrating software and systems to achieve each organisations' individual business goals. For more information please visit www.pro.sony.eu

HCT_VPL-HW500ES_J2131_UK_22/08/2013

SONY
make.believe