

NEC Display Solutions **Projectors**

PH PROJECTOR LENSES

NP25FL NP26ZL NP27ZL NP28ZL NP29ZL NP32ZL



Specifications

Model	NP25FL	NP26ZL	NP27ZL	NP28ZL	NP29ZL	NP32ZL
Order Code	60003278	60003277	60003276	60003284	60003284	100013350
Aperture	2.5	2.5	2.5	2.5	2.5	2.5
Focal Range (mm)	14.6	28.9 - 38.9	39 - 53.4	52.4 - 85.3	84.9 - 142.0	19.4 - 23.3
Projection ratio (WUXGA)	0.67	1.39 - 1.87	1.87 - 2.56	2.56 - 4.16	4.16 - 6.96	0.9 - 1.1
Zoom Ratio	—	1.3	1.3	1.6	1.6	1.2
Screen size (inches)	77 - 215	100 - 500	50 - 500	100 - 500	100 - 500	70 - 600
Projection distance (m)	1.12 - 3.18	2.9 - 20.1	1.9 - 27	5.6 - 44.5	9.1 - 74	1.4 - 14
Shift Area	0	-0.4V +0.55V / +/-0.2H	-0.4V +0.55V / +/-0.2H	-0.4V +0.55V / +/-0.2H	-0.4V +0.55V / +/-0.2H	-0.4V +0.5V / +/-0.2H
Weight (g)	6,500	6,000	5,000	5,000	5,000	4,500

Screen Size and Distance

Screen Size (inches)	NP25FL	NP26ZL	NP27ZL	NP28ZL	NP29ZL	NP32ZL
80"	1.1	—	—	—	—	—
100"	1.4	2.9 - 4.0	4.0 - 5.5	5.6 - 9.0	9.0 - 15.0	1.9 - 2.4
120"	1.7	3.5 - 4.8	4.8 - 6.6	9.0 - 10.8	12.0 - 18.0	2.3 - 2.8
150"	2.2	4.4 - 6.0	6.0 - 8.2	9.0 - 13.5	13.5 - 22.4	3.0 - 3.6
200"	3.0	5.9 - 8.0	8.0 - 11.0	11.1 - 17.9	17.9 - 29.8	3.9 - 4.8
240"	—	7.1 - 9.6	9.6 - 13.2	13.3 - 21.4	21.4 - 35.7	4.7 - 5.7
300"	—	8.9 - 12.0	12.1 - 16.6	16.5 - 26.8	26.7 - 44.5	5.9 - 7.2
400"	—	11.9 - 16.1	16.1 - 22.1	22.0 - 35.6	35.5 - 59.3	7.8 - 9.5
500"	—	14.9 - 20.1	20.2 - 27.0	27.4 - 44.5	44.3 - 74.0	9.6 - 11.8

NP25FL

Order Code **60003278**

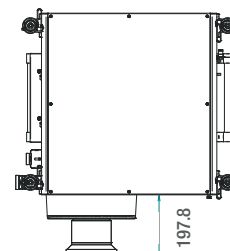
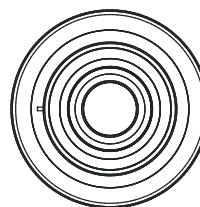
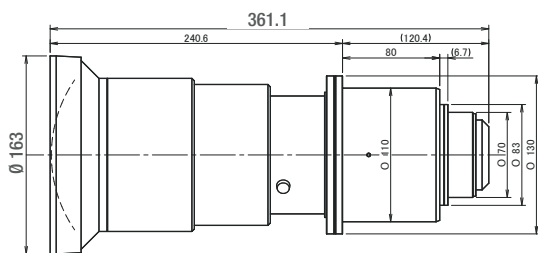

NP26ZL

Order Code **60003277**

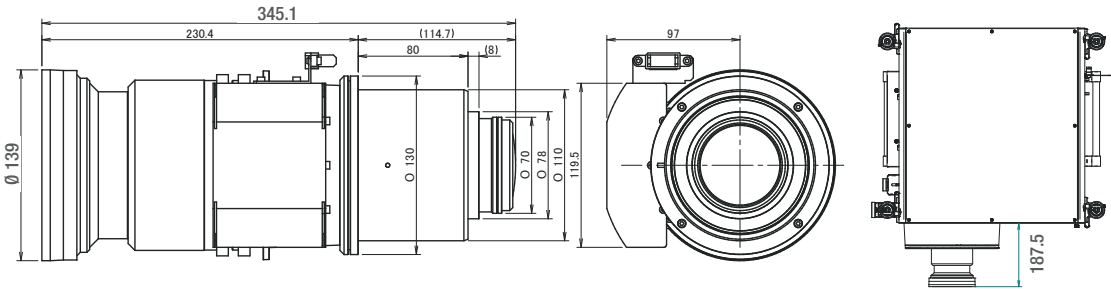

NP27ZL

Order Code **60003276**

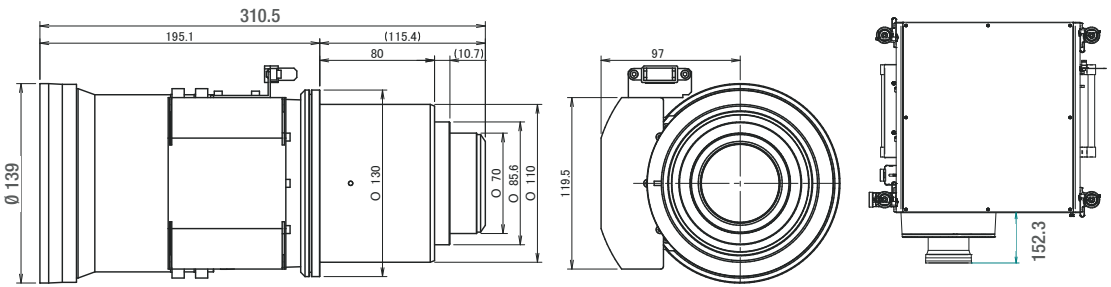

NP28ZL

Order Code **60003284**

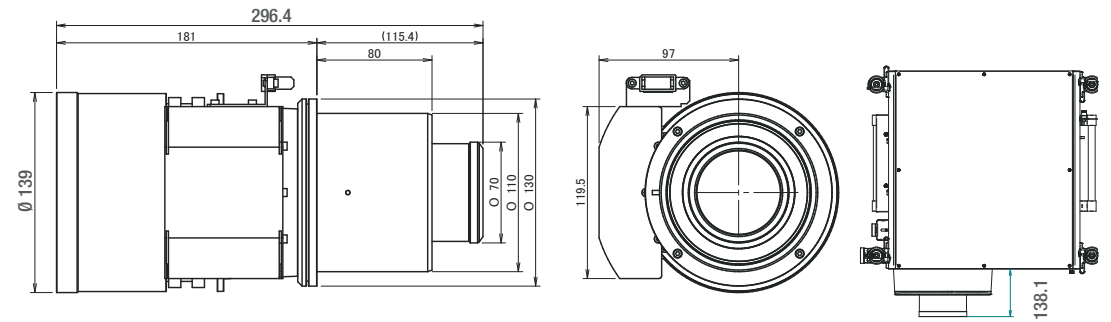

NP29ZL

Order Code **60003284**

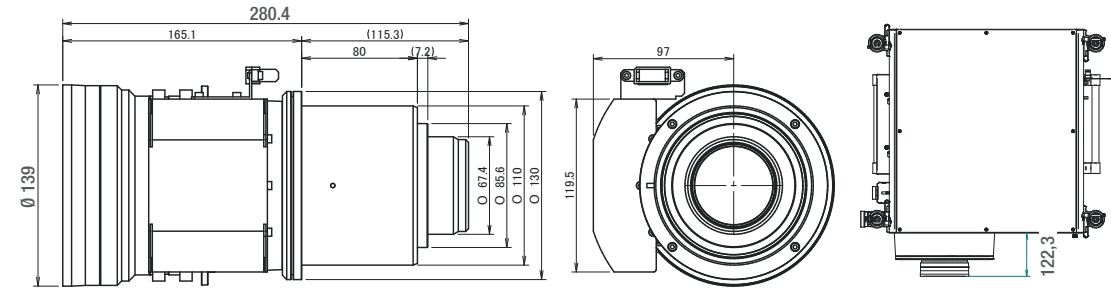

NP32ZL

Order Code **100013350**

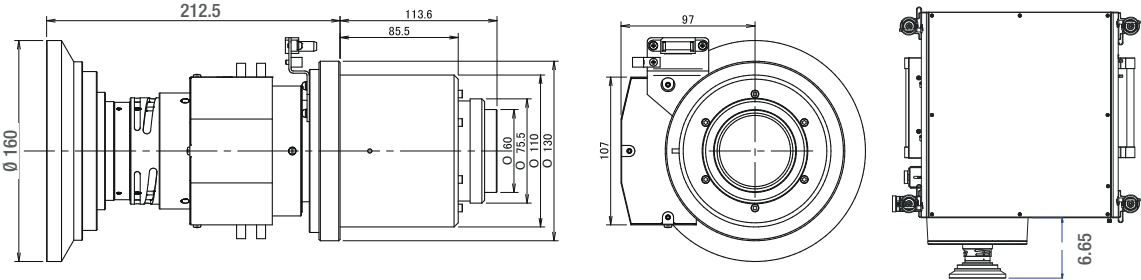

NEC Display Solutions Europe GmbH
Landshuter Allee 12-14, D-80637 München
infomail@nec-displays.com
Phone: +49 (0) 89 99 699-0
Fax: +49 (0) 89 99 699-500
www.nec-display-solutions.com