

Network Management Card

User manual

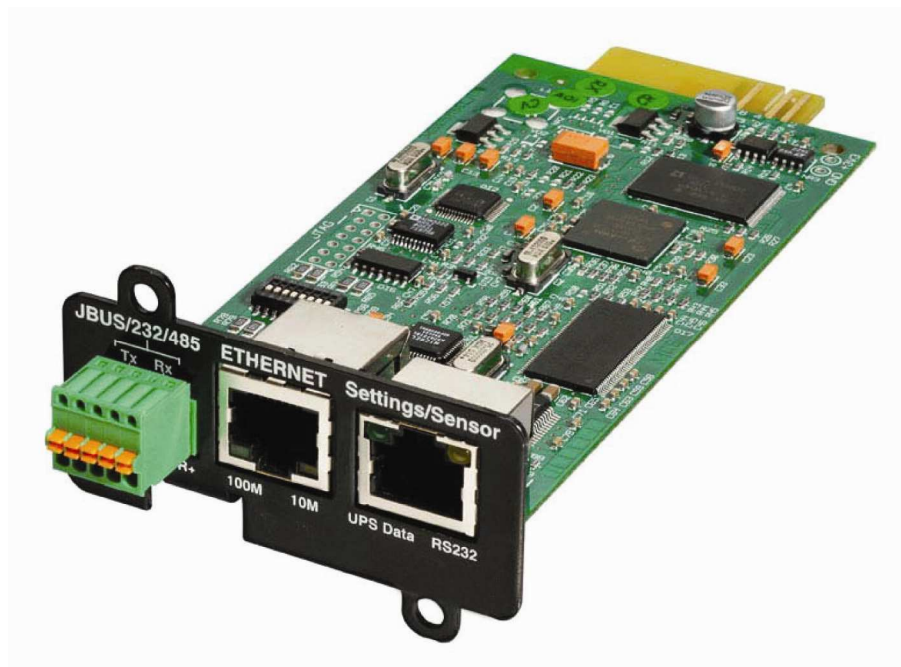
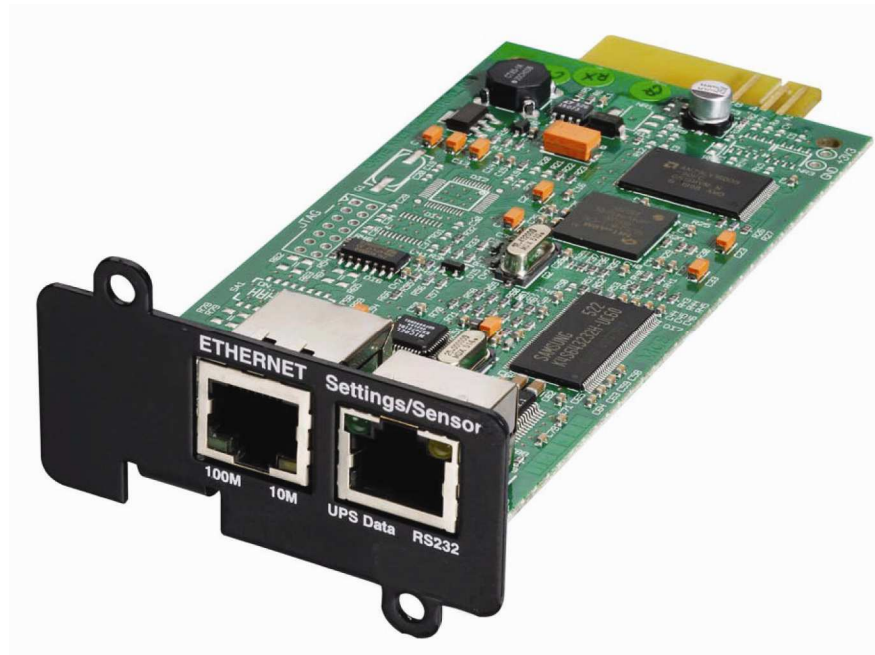

Contents

| | | |
|-------|---|-----------|
| 1 | EATON NETWORK SOLUTION | 5 |
| 1.1 | GENERAL PRESENTATION | 5 |
| 1.1.1 | Connecting the UPS to the Ethernet network | 6 |
| 1.1.2 | Protection of the computers/servers | 6 |
| 1.1.3 | Supervision of the UPSs over the network | 7 |
| 1.1.4 | Connection | 7 |
| 1.2 | PRESENTATION OF THE NETWORK MANAGEMENT CARD (NMC) | 8 |
| 1.2.1 | Compatibility with UPSs | 8 |
| 1.2.2 | Direct sending of E-mail | 9 |
| 1.2.3 | Sending text messages (SMS) | 9 |
| 1.2.4 | Compatibility with the Network Management Systems (NMS) – Trap sending | 9 |
| 1.2.5 | Environment Sensor (option) | 9 |
| 1.3 | TECHNICAL DATA | 10 |
| 1.3.1 | Hardware characteristics | 10 |
| 1.3.2 | EMC Compatibility | 10 |
| 1.3.3 | Configuration | 10 |
| 1.3.4 | Administration | 11 |
| 1.3.5 | Network | 11 |
| 1.3.6 | Environment sensor | 11 |
| 1.3.7 | MIB (Management Information Base) | 12 |
| 1.3.8 | Default parameters | 13 |
| 2 | INSTALLATION | 14 |
| 2.1 | UNPACKING AND CHECK ON CONTENTS | 14 |
| 2.2 | INDICATIONS | 14 |
| 2.3 | INSTALLATION IN THE UPS | 15 |
| 2.4 | SENSOR INSTALLATION (OPTION) | 16 |
| 3 | CONFIGURATION | 17 |
| 3.1 | CONFIGURE IP PARAMETERS | 17 |
| 3.1.1 | Your network is equipped with a DHCP server | 18 |
| 3.1.2 | Your network is not equipped with a DHCP server | 19 |
| 3.2 | TEST AFTER CONFIGURATION | 19 |
| 4 | SUPERVISION AND ADMINISTRATION BY BROWSER | 20 |
| 4.1 | OPTIMISING THE PERFORMANCE OF YOUR BROWSER | 20 |
| 4.2 | UPS | 21 |
| 4.2.1 | UPS properties page | 21 |
| 4.2.2 | On-line help | 33 |
| 4.2.3 | UPS control | 34 |
| 4.2.4 | UPS weekly schedule programming | 37 |
| 4.2.5 | Shutdown parameters | 38 |
| 4.2.6 | Measurements | 40 |
| 4.2.7 | Event log | 41 |
| 4.2.8 | System log | 42 |

| | | |
|-------|---|-----------|
| 4.3 | NOTIFICATION | 43 |
| 4.3.1 | Email Notification | 43 |
| 4.3.2 | E-mail Message Settings | 45 |
| 4.4 | CONFIGURATION | 47 |
| 4.4.1 | Network settings | 48 |
| 4.4.2 | System | 50 |
| 4.4.3 | Notified Applications | 52 |
| 4.4.4 | Central shutdown configuration | 54 |
| 4.4.5 | Access control | 55 |
| 4.4.6 | Date and time | 57 |
| 4.4.7 | Firmware upload | 59 |
| 4.5 | ENVIRONMENT SENSOR (OPTION) | 60 |
| 4.5.1 | Characteristics | 60 |
| 4.5.2 | Environment Status | 61 |
| 4.5.3 | Environment Settings | 62 |
| 4.5.4 | Log | 64 |
| 5 | SERVER PROTECTION | 65 |
| 5.1 | SET-UP OF THE SHUTDOWN PARAMETERS | 65 |
| 5.1.1 | Shutdown criteria managed by the Network Management Card | 65 |
| 5.1.2 | Controlled outlets | 68 |
| 5.1.3 | Protection of a server connected to a controlled outlet | 68 |
| 5.2 | THE DIFFERENT SERVER AND UPS SHUTDOWN SEQUENCES | 69 |
| 5.2.1 | Extended power outage, shutdown initiated by the Shutdown Timer (Shutdown after) | 69 |
| 5.2.2 | Extended power outage, shutdown initiated by the "Low battery power" message | 69 |
| 5.2.3 | Case of power restoration before the end of the "shutdown duration" counter | 70 |
| 5.3 | SHUTDOWN MANAGEMENT WITH 2 NMC BOARDS | 71 |
| 5.3.1 | Shutdown Duration | 71 |
| 5.3.2 | Settings | 71 |
| 6 | CONFIGURATION VIA RS232 | 72 |
| 6.1 | CHOICE 1: RESTART / RESET | 73 |
| 6.2 | CHOICE 2: NETWORK CONFIGURATION | 73 |
| 6.2.1 | Choice 1: Read Network settings | 73 |
| 6.2.2 | Choice 2: Modify Network settings | 74 |
| 6.2.3 | Choice 3: Set Ethernet speed | 74 |
| 6.3 | CHOICE 3: LOST PASSWORD / SET LOGIN PASSWORD TO DEFAULT | 75 |
| 6.4 | CHOICE 4: RETURN TO DEFAULT CONFIGURATION | 76 |
| 7 | INDUSTRIAL NETWORK MANAGEMENT CARD (INMC OPTION) | 77 |
| 7.1 | PRESENTATION | 77 |
| 7.1.1 | Overview | 77 |
| 7.1.2 | Functions | 77 |
| 7.1.3 | Technical characteristics | 78 |
| 7.2 | INSTALLATION | 79 |
| 7.2.1 | RS232 link configuration and connection | 79 |
| 7.2.2 | RS485 link configuration and connection | 80 |
| 7.2.3 | Configuration of the JBUS/MODBUS communication parameters | 86 |

| | | |
|-------|--|------------|
| 7.3 | ADDITIONAL WEB PAGES | 90 |
| 7.4 | JBUS TABLE | 91 |
| 7.4.1 | Data for Pulsar 700 / 1000 / 1500 | 91 |
| 7.4.2 | Data for Pulsar M 2200 / 3000 | 93 |
| 7.4.3 | Data for Pulsar MX 4000 / 5000 / 10000 and EX 5 / 7 / 11 RT | 95 |
| 7.4.4 | Data for Pulsar MX frame 15 / 20 | 97 |
| 7.4.5 | Sensor data | 102 |
| 7.4.6 | Other data | 105 |
| 8 | APPENDICES | 106 |
| 8.1 | TABLES OF ALARMS AND EVENTS | 106 |
| 8.1.1 | Table of alarms | 106 |
| 8.1.2 | Table of UPS events | 109 |
| 8.1.3 | Table of system alarms | 111 |
| 8.2 | SNMP OBJECTS | 112 |
| 8.2.1 | EATON MIB | 112 |
| 8.2.2 | Table des TRAPS : (1.3.6.1.4.1.705.1.11) | 115 |
| 9 | GLOSSARY | 117 |

1 EATON Network Solution

1.1 General Presentation

EATON Network Solution :

- Provides information on events concerning the supply of power to the computers connected to your computer network,
- Carries out automatic shutdown of computer systems,
- Monitors and controls all the UPSs connected to the network.

EATON Network Solution provides 3 main functions:

- Supervision of the UPSs over the Network : Web browser, Enterprise Power Manager, or SNMP NMS.
- Protection of the computers (multi-platform) with :
Network Shutdown Module for EATON.
Netwatch for Powerware UPS.
- Connexion of the UPS to the Network.

1.1.1 Connecting the UPS to the Ethernet network

This function can be performed through network Cards inserted in the UPS (Network Management Card). Also a software "agent" running on a nearby PC that is called the Network Management Proxy can be used.

The Network Management Card or Proxy:

- manages communication with the UPS (as well as local protection of the machine on which Proxy is installed)
- periodically accesses the information concerning the UPS
- makes this information available to the connected applications (Network Shutdown Modules, Netwatch, Web Browser, Network Management Systems, Enterprise Power Manager)
- sends notifications on certain events.

Operation may be in standard secure mode (the default mode) or in SSL secure mode (Secure Socket Layer SSL).

1.1.2 Protection of the computers/servers

This function is performed by :

- Network Shutdown Module for EATON
- Netwatch for Powerware UPS

installed on each of the servers to be protected.

Note that Network Shutdown Module and Netwatch are available on several Operating Systems.

Both protection applications:

Continuously waits for information from the Network Management Card/Proxy connected to the UPS.

Warns administrators and users if AC power fails and proceeds with graceful system shutdown before the end of battery backup power is reached.

1.1.3 Supervision of the UPSs over the network

Depending on your needs, you can either use:

Your Internet browser to monitor each UPS, as Management Proxy and Management Card includes a Web server
Your company's standard Network Management System (HP-Openview, CA Unicenter, HP Insight Manager, IBM Tivoli Netview)

To simplify integration of EATON UPSs, you can use one of the Network Management System Kits for EATON devices. These kits are available on the Management Pac 2 CD-ROM. (ref 66923)

The supervisor "Enterprise Power Manager".

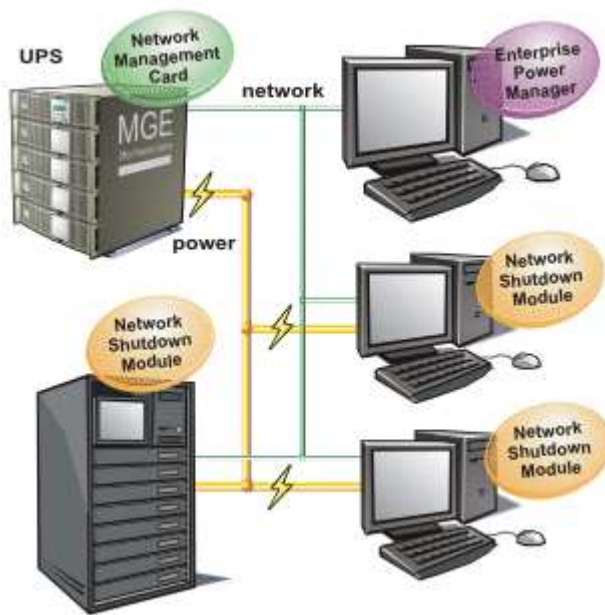

1.1.4 Connection

Before installing the Network Solution, the UPS must be set up as indicated in the steps below.

Shut down the computers to be protected by the UPS.

Connect the UPS to a wall outlet. (For UPSs above 3kVA, please refer to the UPS installation manual).

Connect the power cord of each computer to an outlet on the UPS. (For UPSs above 3kVA, please refer to the UPS installation manual)

1.1.4.1 How to connect UPS / agent / network:

Insert the optional card in the UPS and connect the UPS to the computer network.
Start the UPS, then the computers.

1.1.4.2 Setting up the protection:

Set up the Network Management Card (see user manual).

Install and configure the protection application on all machines that are to be protected by the UPS :

- Network Shutdown Module for EATON UPS : The software components for each platform and the user manuals are on the Solution-Pac-2 CD or available at download.eaton.com
- Netwatch for Powerware UPS : The software components for each platform and the user manuals are available at powerware.com

1.2 Presentation of the Network Management Card (NMC)

1.2.1 Compatibility with UPSs

The Minislot Network Management Card is compatible with the UPS listed into the compatibility list :

- available at download.eaton.com for the EATON UPS.
- available at powerware.com for the Powerware UPS.

Network Management Cards acquire information on the operation status of the UPS systems and provide remote control of these systems by means of an ETHERNET network from any SNMP administration station or Web browser.

They also supply alarms to the Network Shutdown Modules to trigger shutdown or other automatic actions for protected servers.

Network Management Cards are compatible with the "Enterprise Power Management" supervision system, with the EATON network protection system and with Powerware Netwatch.

[Network Shutdown Module](#)
[Enterprise Power Manager](#)
[Management-Pac 2](#)

1.2.2 Direct sending of E-mail

When a UPS event occurs, the Network Management Card can directly notify up to 4 intranet or extranet addresses by e-mail. (see E-mail Notification and [E-mail message settings](#))

1.2.3 Sending text messages (SMS)

The card offers the possibility of redirecting UPS alarms to an e-mail server. The format of these e-mails is compatible with mobile telephone e-mail/SMS transfer systems proposed by ISPs. The format to be used depends on the service provider.

For example, sms.0660256585@votre-login.activmail.net (text messages).

1.2.4 Compatibility with the Network Management Systems (NMS) – Trap sending

The Network Management Cards are compatible with the major Network Management Systems (IBM Tivoli, CA Unicenter, HP Insight Manager). The Management-Pac 2 offering includes the necessary SNMP plug-ins to allow an easy integration in the NMS. Events are notified by SNMP trap.

NMS can subscribe on page "[Notified Applications](#)"

The trap list is given in the [appendix](#).

1.2.5 Environment Sensor (option)

The [Environment Sensor](#) (66846) solution comprises a box to be connected to the Card Settings port of the Network Management Cards.

Environment Sensor enables measurement of temperature and humidity around the UPS, consideration of external alarms via 2 dry contacts and notification of alarms according to pre-programmed thresholds. (see [Environmen Status](#) and [Environment Configuration](#))

1.3 Technical data

1.3.1 Hardware characteristics

Dimensions

| | |
|------------------------|------------------|
| Dimensions (L x l x H) | 132 x 66 x 42 mm |
| Weight (gr) | 70 g |

Storage

| | |
|---------------------|-----------------|
| Storage temperature | -10 °C to 70 °C |
|---------------------|-----------------|

Ambient conditions

| | |
|-----------------------|----------------------------------|
| Operating temperature | 0 °C to 40 °C |
| Ambient humidity | 90 % RH max without condensation |
| ROHS | 100 % compatible |

1.3.2 EMC Compatibility

When correctly installed and used in accordance with the manufacturer's instructions, the Network Management Card complies with the following standards:

Safety for ATI: IEC/EN 60950-1 2002

EMC: EN 61000-6-2 (2002), EN 61000-6-3 (2002). IEC/EN 62040-2 (2002).

As per European directives:

Low voltage: 73/23/EEC and 93/68/EEC

EMC: 89/336/EEC and 93/68/EEC.

1.3.3 Configuration

The user can configure the card with one of the following means:

Web browser

Local serial link (network parameters)

BOOTP/DHCP (network parameters).

1.3.4 Administration

Up to 35 workstations(in TCP connected mode) or up to 100(in UDP broadcasted mode) protected by Network Shutdown Modules - Central or local configuration.

Up to 5 browsers connected at the same time (3 in SSL).

- Minimum recommended browser versions: Internet Explorer 6.x / 7.0, Mozilla Firefox 1.5 / 2.0 / 3.0

E-mail sending configurable according to UPS alarms and transmission of a periodical report.

Control of UPS on/off switching via the HTML interface.

Adjustment and control of PowerShare outlets via the HTML interface, sequential starting of the installation and optimisation of backup time by shutting down non-priority systems.

Automatic data and time adjustment via NTP server.

Protection by encrypted password.

Protection by secure SSL connection.

Saving of logs in the non-volatile memory.

Languages available: English/French/Spanish/German/Italian.

On-line help in English available for each page.

Card firmware updated via the network.

Card Mass settings via the network with the NMC tool.

1.3.5 Network

- Fast ETHERNET 10/100 Mbits compatibility with auto-negotiation on the RJ45 outlet.

1.3.5.1 List of ports used

- | | |
|-------------------------|-------------------|
| • BootP, DHCP | UDP 68, 67 |
| • HTML | TCP 80 |
| • SSL | TCP 443 |
| • NSM in connected mode | TCP 5000 |
| • NSM in broadcasted | UDP 4679 and 4680 |
| • SMTP | 25 |
| • NTP | 123 |
| • SNMP V1 | 161 |
| • TRAP SNMP | 162 |

1.3.6 Environment sensor

- Temperature measurement from 0 to 70 °C with +/- 1 °C accuracy.
- Measurement of humidity from 0 to 100 % with +/- 6 % accuracy.
- Min / max time-stamped function for temperature and humidity.
- Choice of temperature readings in Celsius or Fahrenheit.
- High and low thresholds, hysteresis and offset adjustable via Web interface.
- Possibility of notification of status changes by e-mail, SMS or SNMP trap.
- Position detection of 2 dry contacts (maximum sensor/contact distance: 20 m).
- Name and status of each configurable contact.

- Recording of events and measurements in the card log
- Possibility of shutting down the installation in the event of a threshold being exceeded or on opening / closure of a dry contact
- Connection to the card with straight CAT5 RJ45 network cables (maximum card/sensor distance: 20 m)
- Hot installation

1.3.7 MIB (Management Information Base)

- Compatible with MIB EATON V1.7
The list of objects managed can be found in the [appendix](#)

1.3.8 Default parameters

| Function | Parameter | Default value | Possible value |
|--------------------------------|---------------------------------|---|---|
| Network | IP address | 172.17.16.16 | Network IP address |
| | Subnet mask | 255.255.0.0 | Network IP address |
| | Gateway Address | 0.0.0.0 | Network IP address |
| | BOOTP/DHCP | Enabled | Active / Deactivated |
| | Firmware Upload | Enabled | Active / Deactivated |
| | SMTP server | smtpserver | 49 characters maximum |
| System | UPS Contact | Computer Room Manager | 49 characters maximum |
| | UPS Location | Computer Room | 31 characters maximum |
| | History log interval (sec.) | 60 | 10 to 99999 sec. |
| | Environment log interval (sec.) | 300 | 10 to 99999 sec. |
| | Default Language | English | English / French / Spanish / German / Italian |
| Manager table | | empty | 50 maximum |
| Access control | User name | admin | 10 characters maximum |
| | Password | admin | 10 characters maximum |
| | Community name read | public | 49 characters maximum |
| | Trap port | 161 | Non configurable |
| Date and time | Date and time adjustment | Accept automatic update from NSM or EPM | Synchronise with an NTP server Accept automatic update from NSM or EPM Synchronise manually |
| | NTP server | ntpserver | 49 characters maximum |
| Serial link | Speed | 9600 baud | Non configurable |
| | Data bits | 8 | Non configurable |
| | Stop bits | 1 | Non configurable |
| | Parity | without | Non configurable |
| | Flow control | without | Non configurable |

2 Installation

2.1 Unpacking and check on contents

The installation kit contents:

- A Network Management Card (66102)
- A serial communication cable for configuration (34003918)
- Installation manual (34003905)

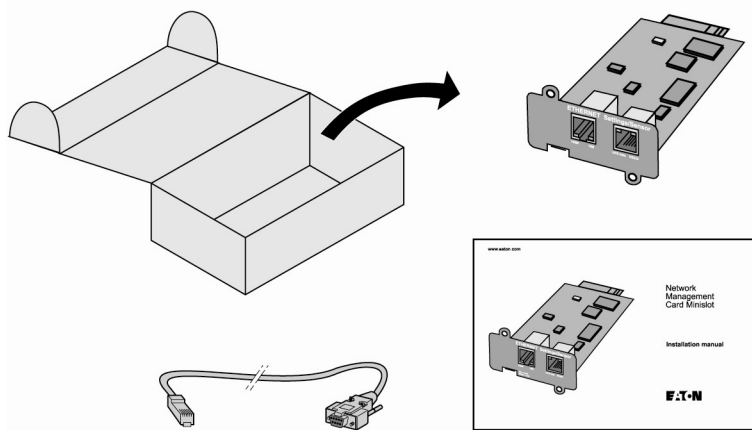

2.2 Indications

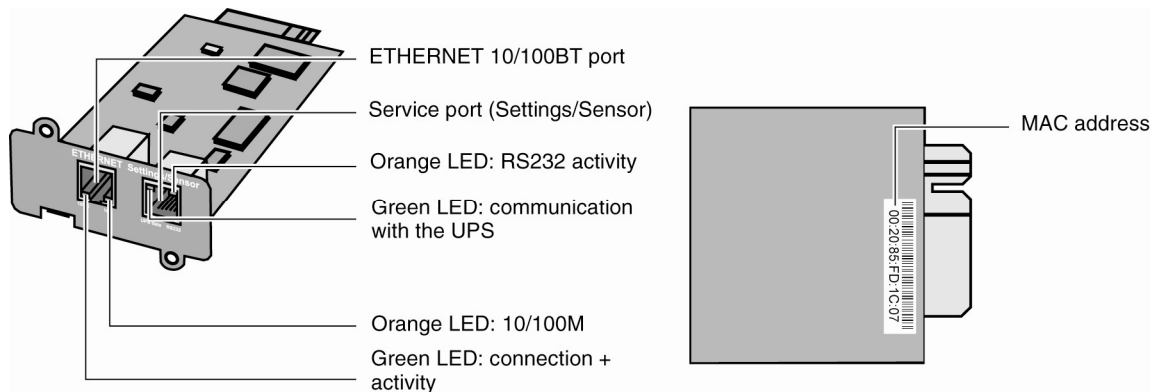

Ethernet port

| LED | Colour | Activity | Description |
|------|--------|---|--|
| ACT | Green | <ul style="list-style-type: none">• Off• On• Flashing | <ul style="list-style-type: none">• Card not connected to the network.• Card connected to the network but without activity• Port is active in receiving / transmission |
| 100M | Orange | <ul style="list-style-type: none">• Off• On | <ul style="list-style-type: none">• Port operating at 10Mbps/s.• Port operating at 100Mbps/s. |

Service port

| LED | Colour | Activity | Description |
|-------------|--------|---|--|
| UPS Data | Green | <ul style="list-style-type: none">• Off• On• Flashing | <ul style="list-style-type: none">• Card startup in progress.• Communication with UPS in progress• Normal operation. Communication with the UPS is operational |
| RS232 | Orange | <ul style="list-style-type: none">• Off• On• Flashing | <ul style="list-style-type: none">• Configuration menu is active• Normal operation. Configuration menu is deactivated• Communication with the Environment Sensor (option). |

2.3 Installation in the UPS

The Network Management Card (66102) can be "hot" installed in all UPSs of the EATON or Powerware range equipped with a Minislot without having to shut it down.

- Remove the protective plastic cover from the Minislot
- Note the card's MAC address prior to insertion
- Insert and tighten the card's retaining screws
- Connect the ETHERNET cable
- Wait 2 min. the card is completely operational when the green UPS Data LED flashes continuously

2.4 Sensor installation (option)

The Environment sensor is available as an option on the Network Management Card and is available from EATON (reference 66846).

The sensor allows remote monitoring of the UPS's environment through regular measurements: temperature, humidity, status of two external contacts. It also enables notification of alarms (e-mail, trap SNMP) according to pre-programmed thresholds.

It is connected to the Service port (Settings/Sensor) directly on the Network Management Card with a standard Ethernet cable (20 meters maximum).

Recognition is automatic. Supervision and configuration are performed via a menu that can be accessed directly from the home page.

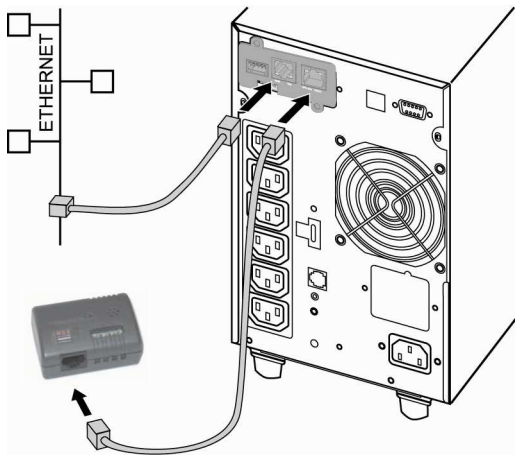

3 Configuration

3.1 Configure IP parameters

Once the card has started:

Connect one end of the cable (34003918) to the Service port.

If the environment sensor was previously connected, the card must be restarted in order to access the configuration menu.

Connect the other end of the cable to the COM port (IOIO) of a PC.

Launch a HyperTerminal™ type emulator with the following configuration:

Speed: 9600

Data bits: 8

Parity: none

Stop bits: 1

Flow control: none

"Locally reproduce the characters entered" option: deactivated.

Enter admin. The main menu is displayed:

```
-----  
EATON  
NETWORK MANAGEMENT CARD  
-----  
1 : Reset  
2 : Network configuration  
3 : Set Login Password to Default  
4 : Return to Default Configuration  
0 : Exit  
-----
```

3.1.1 Your network is equipped with a DHCP server

The card is configured by default with this service activated.

The card automatically collects IP parameters.

To know the IP parameters, type 2, the next menu is displayed:

```
-----  
Network settings  
-----  
1 : Read Network settings  
2 : Modify Network settings  
3 : Set Ethernet speed  
0 : Exit  
-----
```

Then type 1. The menu is displayed:

```
Network configuration :  
MAC address : 00:20:85:FD:1C:07  
Mode : Static IP  
IP address : 166.99.21.94  
Subnet mask : 255.255.248.0  
Gateway 166.99.17.1
```

Note the IP address.

To exit, enter 0 then 0. The card is operational.

Note: As long as the card is not connected to the network, it continuously attempts to make connection. Once the connection has been established, the operational mode presented in the table above becomes effective.

3.1.2 Your network is not equipped with a DHCP server

In the main menu enter 2, then 2 again. The menu is displayed:

Follow the instructions and enter the static IP parameters.

At the end of the menu, wait for the "Done" message to be displayed indicating that the IP parameters have been saved.

```
-----  
Network settings  
-----  
1 : Read Network settings  
2 : Modify Network settings  
3 : Set Ethernet speed  
0 : Exit  
-----  
For each of the following questions, you can press <Return> to select the value  
shown in braces, or you can enter a new value.  
Should this target obtain IP settings from the network?[N] N  
Static IP address [166.99.21.94]? 166.99.21.21  
Static IP address is 166.99.21.21  
Subnet Mask IP address [255.255.248.0]? 255.255.255.0  
Subnet Mask IP address is 255.255.255.0  
Gateway address IP address [166.99.17.1]? 166.99.17.1  
Gateway address IP address is 166.99.17.1  
Wait during your new configuration is saved ...  
Reset the card to take into account the new configuration.
```

Return to the main menu and enter 1 then 2.

The card restarts with the new IP parameters.

3.2 Test after configuration

To check that the Network Management Card is operational after installation and configuration.

From a station connected to the same subnet as the card, open a web browser and enter the IP address of the card in the address field

Check the display of the [home page](#).

4 Supervision and administration by browser

- On a computer equipped with a Web browser (Internet Explorer, FireFox or Netscape recommended), enter the address initialised previously in the Installation chapter (e.g. <http://166.99.21.21>.)
The "UPS properties" home page is displayed.

4.1 Optimising the performance of your browser

- To view status changes on the UPS in real time, the browser must be configured so that it automatically refreshes all the objects on the current page.
Example on IE 6: Tools / Internet Options / General / Parameters menu, tick Every time this page is visited and validate.

4.2 UPS

4.2.1 UPS properties page

This page is automatically refreshed every 10 seconds.

From this page, access to the main UPS information is available thanks to the combo box (see screen copy below).

The different choices are the following ones:

“UPS Status”: (chosen by default) this page gives instant access to the essential information about your UPS.

“UPS Alarms”: to view the list of current alarms.

“UPS Modules”: (available on modular UPS) to view general information on each modules.

“About your UPS”: provides information on the UPS and the card, in particular, the model range and software version.

These different pages are detailed in the following chapters.

Network Management Card

The screenshot shows the 'UPS Properties' page in a web interface. On the left is a sidebar with three main sections: 'UPS' (containing 'UPS Properties', 'UPS Control', 'Weekly Schedule', and 'Shutdown Parameters'), 'Logs and Notification' (containing 'Measurements', 'Event Log', 'System Log', and 'Email Notification'), and 'Settings' (containing 'Network', 'System', 'Notified Applications', 'Access Control', 'Time', and 'Firmware Upload'). The main content area is titled 'UPS Properties' and includes a 'Help' link. It features a diagram of a 'Pulsar M 2200 Computer Room' UPS system with a green checkmark icon. Below the diagram is a dropdown menu set to 'UPS Status'. The main content is organized into several sections: 'Power source' (AC Power), 'Output load level' (3%), 'Output' (Master, Group1, and Group2 all On), 'Battery' (100% Charging), 'Remaining backup time' (1 h 37 mn 43 s), and 'Battery status' (OK). The last update is noted as 2008/06/12 17:24:21.

| UPS Status | |
|-------------------------|--|
| Power source : | AC Power |
| Output load level : | 3% |
| Output : | Master : On Group1 : On Group2 : On |
| Battery | |
| Battery load level : | 100% Charging |
| Remaining backup time : | 1 h 37 mn 43 s |
| Battery status : | OK |

Last update : 2008/06/12 17:24:21

4.2.1.1 "UPS" zone: general information on the UPS.



Indication of the picture and generic name of the UPS range

Computer room: Customised name of your system.

You can change this name on the ["System"](#) page.

UPS status icon :

The various icons showing the status of the UPS are:

| | |
|---|--|
|  | Normal operation |
|  | Alarm present. This icon links directly to the alarm page. |
|  | Loss of communication with the UPS |

Animated synoptic: An animated synoptic gives a global overview of the UPS current operating mode.

This synoptic is available on all On-Line UPS.

The synoptic drawing depends on the UPS topology. The different drawings are described in the table below.

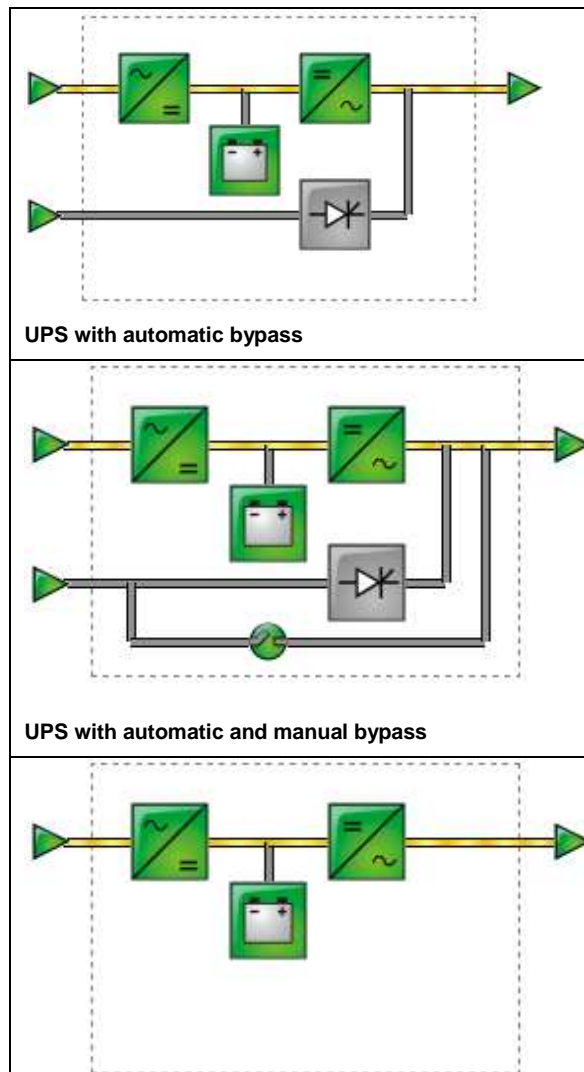



UPS without automatic bypass



Note: In case of loss of communication with the UPS, all the elements of the synoptic are grey.

The various elements of the synoptic are the following ones:



- AC Normal Input :

| | |
|---|-------------------|
|  | In tolerances |
|  | Out of tolerances |



- AC Normal Flow :

| | |
|---|---|
|  | AC to DC converter powered by AC Normal |
|  | AC to DC converter not powered by AC Normal |



- AC to DC Converter:

| | |
|---|------------------|
|  | Powered |
|  | Not powered |
|  | Internal failure |



- **Battery :**

| | |
|---|---|
|  | Remaining capacity > 50% |
|  | Remaining capacity < 50% |
|  | Battery to be checked (battery test result) |



- **Battery Output Flow :**

| | |
|---|---|
|  | DC to AC converter powered by battery |
|  | DC to AC converter not powered by battery |



- **DC to AC Converter Input flow :**

| | |
|---|---------------------|
|  | Energy flow present |
|  | No energy flow |



- **DC to AC Converter :**

| | |
|---|------------------|
|  | Powered |
|  | Not powered |
|  | Internal failure |



- **DC to AC Converter Output :**

| | |
|---|---------------------|
|  | Energy flow present |
|  | No energy flow |

- **AC Bypass Input :**

| | |
|---|-------------------|
|  | In tolerances |
|  | Out of tolerances |



- **AC Automatic Bypass Flow :**

| | |
|---|---------------------|
|  | Energy flow present |
|  | No energy flow |



- **AC Automatic Bypass Status :**

| | |
|---|------------------|
|  | Powered |
|  | Not powered |
|  | Internal failure |



- **AC Manual Bypass Flow :**

| | |
|---|---------------------|
|  | Energy flow present |
|  | No energy flow |



- **AC Manual Bypass Status :**

| | |
|---|--------|
|  | Open |
|  | Closed |

- **AC Output Flow :**

| | |
|---|---------------------|
|  | Energy flow present |
|  | No energy flow |

- **AC Output :**

| | |
|---|--------------------|
|  | Load protected |
|  | Load not protected |

- **UPS measurements :**
- **Boxes showing measurements appear when synoptic elements are hovered by the pointer. See example below.**

Network Management Card

UPS

- [UPS Properties](#)
- [UPS Control](#)
- [Weekly Schedule](#)
- [Shutdown Parameters](#)

Logs and Notification

- [Measurements](#)
- [Event Log](#)
- [System Log](#)
- [Email Notification](#)

Settings

- [Network](#)
- [System](#)
- [Notified Applications](#)
- [Access Control](#)
- [Time](#)
- [Firmware Upload](#)

UPS Properties
Help



Pulsar M 2200
Computer Room

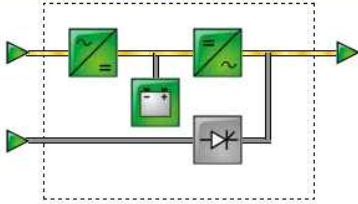

AC Output

| | |
|----------------|---------|
| Voltage | 231 V |
| Current | 0.4 A |
| Frequency | 50.0 Hz |
| <hr/> | |
| Load level | 4 % |
| Apparent Power | 0.0 KVA |
| Active Power | 0.0 KW |

UPS Status: ▼

| | |
|-------------------------|--|
| Power source : | AC Power |
| Output load level : | <div style="display: flex; align-items: center;"> <div style="width: 100px; height: 10px; background: repeating-linear-gradient(90deg, transparent, transparent 2px, #ccc 2px, #ccc 4px);"></div> 4% </div> |
| Output : | <ul style="list-style-type: none"> ● Master : On ● Group1 : On ● Group2 : On |
| Battery | |
| Battery load level : | <div style="display: flex; align-items: center;"> <div style="width: 100px; height: 10px; background: repeating-linear-gradient(90deg, transparent, transparent 2px, #008000 2px, #008000 4px);"></div> 100% Charging </div> |
| Remaining backup time : | 1 h 37 mn 43 s |
| Battery status : | OK |



Last update : 2008/06/12 17:25:35

These measurements are available for AC to DC converter, Battery, DC to AC converter and automatic bypass. The measurements available in these boxes depend on the UPS range.

4.2.1.2 "UPS status" zone: Essential information

- "Active sources": (available on parallel or modular UPS)
 - x UPS + y UPS redundant : x indicates the minimal number of UPS necessary to power the load, y indicates the number of UPS in redundancy.
 - An alarm can be generated if the number of UPS in redundancy is less than a configurable threshold. See UPS modules section.
- "Power source": indicates whether the power comes from the utility or from the UPS battery
- "Output load level": indicates the power percentage used at UPS output
- "Output": indicates if the different UPS outputs are protected.
- "Master": indicates if the UPS main output is protected
- "Group1 and Group2": indicates if the controlled outlets (if available) are powered.

The various icons showing the status of the UPS outputs are:

| | |
|--|-------------------------------------|
|  (green outlet) | Outlet powered |
|  (red outlet) | Outlet not powered or not protected |

Battery Information :

- "Battery load level": remaining battery charge (in percent).
The information is completed with the two following labels:
- "Charging" : if the utility power is present and the battery charge is in progress
- "Discharging": if the UPS operates on battery.
- "Fault": if the battery is faulty.
- "Remaining backup time": Estimation of the battery's maximum backup time remaining before UPS shutdown
- "Battery status": Result of the last automatic battery test carried out by the UPS
Possible values are:
 - OK: the test was completed correctly
 - NOK: the battery needs to be checked
 - Deactivated: the automatic battery test is not validated on the UPS

- The Status can take the next forms:



or



when the module is working properly with no alarm.



when the module has at least one alarm (level Warning) active.



when the module has at least one alarm (level Critical) active.



when the module has a communication fault.

When the module is working properly with no alarms, the icon is not reactive, otherwise it is reactive and clicking on it makes the page Alarm Table appear.

- "Output load level": Value of the percentage of load at module output
- "Battery load level": Percentage of charge available in the battery module

4.2.1.4 Viewing the alarms

Click on "Alarm Table" scroll list to view the list of current alarms. The table of managed alarms is included in the [appendix](#).

The level of the alarms appears like below:

-  **Critical**
-  **Warning**
-  **Unknown**

- Alarm table for standard UPS

Network Management Card

UPS

- UPS Properties
- UPS Control
- Weekly Schedule
- Shutdown Parameters

Logs and Notification

- Measurements
- Event Log
- System Log
- Email Notification

Settings

- Network
- System
- Notified Applications
- Access Control
- Time
- Firmware Upload





UPS Properties Help

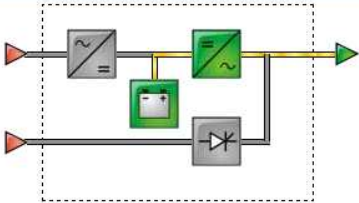

Pulsar M 2200
Computer Room



UPS Alarms

| | Alarm Time | Alarm Description | Severity |
|-----|---------------------|------------------------------------|---|
| UPS | 2008/06/12 17:28:46 | Normal AC voltage out of tolerance |  |
| | 2008/06/12 17:28:49 | Normal AC NOK |  |
| | 2008/06/12 17:28:49 | UPS on battery |  |
| | 2008/06/12 17:28:51 | Bypass AC voltage out of tolerance |  |

- Alarm table for modular UPS

Network Management Card

UPS

- UPS Properties
- UPS Control
- Weekly Schedule
- Shutdown Parameters

Logs and Notification

- Measurements
- Event Log
- System Log
- Email Notification

Settings

- Network
- System
- Notified Applications
- Access Control
- Time
- Firmware Upload

UPS Properties Help

Pulsar MX Frame 16U
Computer Room

UPS Alarms

| | Alarm Time | Alarm Description | Severity |
|-----|---------------------|--|----------|
| UPS | 2008/06/18 10:11:55 | Load not protected - On Automatic Bypass | ⚠ |

4.2.1.5 Viewing the “About your UPS” window

Click on "About your UPS" scroll list to view the information about the UPS and the card.

Network Management Card

UPS

- UPS Properties
- UPS Control
- Weekly Schedule
- Shutdown Parameters

Logs and Notification

- Measurements
- Event Log
- System Log
- Email Notification

Settings

- Network
- System
- Notified Applications
- Access Control
- Time
- Firmware Upload

UPS Properties Help



Pulsar M 2200
Computer Room



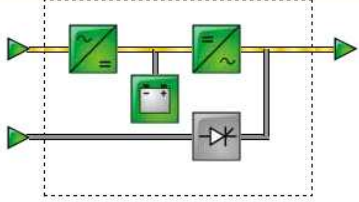

About your UPS ▼

| | |
|--|---------------|
| UPS Name : | Pulsar M 2200 |
| UPS Serial Number : | 012345678 |
| UPS Technical Level : | unknown |
| System Technical Level / Firmware Revision : | SW. AH |

Network Management Card

| | |
|-----------------------------|-------------------|
| Card Firmware revision : | EBb3 |
| Card Commercial Reference : | 66102 |
| Card Technical Level : | 01 |
| Card Revision : | CA |
| Card Serial Number : | 49HF5100H |
| Card Ethernet Mac Address : | 00:06:23:00:1C:68 |
| Card Ethernet Speed : | 100 Mbit |

4.2.2 On-line help

On-line contextual help in English is available at the top of each page by clicking on the Help link, which is always located on the top right corner. The navigation menu of the on-line help is identical to that of the card's pages.

The Help page always opens a new window.

Network Management Card

UPS

- UPS Properties
- UPS Control
- Weekly Schedule
- Shutdown Parameters

Logs and Notification

- Measurements
- Event Log
- System Log
- Email Notification

Settings

- Network
- System
- Notified Applications
- Access Control
- Time
- Firmware upload

UPS Properties Help

This is the page by default, displaying the fundamentals status of the UPS.

At the top of the page, the UPS is identified : image, name and location.

The alarm icon above the UPS image shows if an alarm is active when it is red, click on it to see the current alarm page. When there is no alarm the green icon is displayed.

The electric diagram of the UPS is displayed showing the electrical flow which powers the load and also the main parts of the UPS.

The electric diagram is not available for Line Interactive UPS.

The second part of the page is refreshing every 10 seconds and contains informations depending of the selection in the combo box :

UPS Status selects the main status of the UPS :

Active sources shows the current use of a modular UPS, the notation x UPS + y UPS is meaning : x is the number of modules necessary to power the load, y is the number of redundant modules.

Power source shows where the power comes from.

Output load level shows the load level.

Output shows the status of all UPS outputs.

UPS Modules selects the status of the modules of the UPS, available only for modular UPS :

Each module of the UPS has static informations as the serial number, or dynamic information as the global status showed with an alarm icon and also its percent load and battery level.

4.2.3 UPS control

Click on the "UPS Control" section in the menu

The parameters of this menu can only be modified after entering the "Login" and "Password". The following screen is proposed automatically:



The default login and password are: admin/admin

Each field accepts up to 10 characters max.

After the login and password are entered, they remain active for 5 minutes.

If the browser is closed, they will have to be re-entered.

An error in either field results in systematic rejection of the requested action (save, page access, card reboot...). After three unsuccessful attempts, the browser must be rebooted.

These two fields do not travel "decoded" on the IT network. They are encrypted with an MD5 type algorithm, ensuring total confidentiality.

In the event of [password loss](#), the user can return to the default values via the maintenance menu.

UPS configuration may prevent the shutdown and restart commands from being properly run. Read the UPS user manual for more information.

Network Management Card

The screenshot shows the 'UPS Control' interface for a 'Pulsar M 2200' UPS in a 'Computer Room'. The interface includes a sidebar with navigation options: UPS (UPS Properties, UPS Control, Weekly Schedule, Shutdown Parameters), Logs and Notification (Measurements, Event Log, System Log, Email Notification), and Settings (Network, System, Notified Applications, Access Control, Time, Firmware Upload). The main area features a table with the following data:

| Output | Status | Control | Off Delay | Toggle Duration | On Delay |
|--------|--------|--------------------------|-----------|-----------------|----------|
| Master | On | Safe power down & reboot | | 0 sec | |
| Group1 | On | None | 0 sec | 0 sec | 0 sec |
| Group2 | On | None | 0 sec | 0 sec | 0 sec |

Below the table are 'Execute' and 'Save' buttons.

This page enables triggering of [startup and shutdown sequences](#) for the UPS main output and controlled outlets.

- The status of each output is displayed by a symbol associated with the Off label (red symbol) or On (green symbol).
- The shutdown sequences take into account the time required for the registered servers to shut down without losing data ([see shutdown parameters](#)).
- The main outlet has priority over the controlled outlets. Shutdown of the main outlet causes the controlled outlets to shut down. Controlled outlets can only be started if the master outlet is on.

The Check column proposes six different commands, and a command is only actually started after clicking on 'Execute':

"Safe power down": A sequence to switch off output power is launched immediately. The systems supplied are shut down correctly while the shutdown sequence is running, then the output is cut.

"Safe power down & reboot": A sequence to switch off then restore output power is launched immediately. The powered systems are shut down correctly during the shutdown sequence, then the output is switched off. Finally, the restart sequence is launched at the end of the time delay specified in the "Toggle duration" parameter. The output status is updated.

"Immediate On": A sequence to switch on output power is launched immediately. The output is re-powered and the systems supplied start up correctly.

"Delayed, safe power down": This is the same switch off sequence as for the "Safe power down" command, but postponed by the number of seconds programmed in the "Off Delay" parameter.

"Delayed, safe power down & reboot": This is the same switch off then on sequence as for the "Safe power down & reboot" command, but postponed by the number of seconds programmed in the "Off Delay" parameter.

"Delayed On": This is the same switch on sequence as for the "Immediate On" command, but postponed by the number of seconds programmed in the "On Delay" parameter.

The Save button saves the Off Delay, Toggle duration and On Delay parameters on the card.

Security: The administrator must click on Save and enter his/her login/password to save modifications or run commands. The default login and password by default are: admin/admin

4.2.4 UPS weekly schedule programming

Click on the "Weekly schedule" section of the menu.

Network Management Card

UPS

- UPS Properties
- UPS Control
- Weekly Schedule
- Shutdown Parameters

Logs and Notification

- Measurements
- Event Log
- System Log
- Email Notification

Settings

- Network
- System
- Notified Applications
- Access Control
- Time
- Firmware Upload

Weekly Schedule Help

Pulsar M 2200 Computer Room

| Day | Shutoff Time | Restart Time |
|-----------|--------------|--------------|
| Sunday | - | 22:00 |
| Monday | 20:00 | 06:30 |
| Tuesday | - | - |
| Wednesday | - | - |
| Thursday | - | - |
| Friday | - | - |
| Saturday | - | - |

UPS configuration may prevent the shutdown and restart commands from being properly run. Read the UPS user manual for more information.

The weekly schedule enables the administrator to optimise power consumption or program a reboot of the protected equipment at a set time.

In a shutdown sequence, the Network Shutdown Modules connected to the card are informed and ensure that each machine is shut down correctly before the UPS output is switched off. Up to 7 UPS shutdown sequences can be programmed in one week, with a minimum shutdown delay of 30 minutes.

The On / Off sequences are valid only if the card's time has been properly set.



Security: The administrator clicks on "Save" and enters his/her login / password to save any edits. The login and password by default are: admin/admin

4.2.5 Shutdown parameters

This page enables viewing and configuration of UPS operating parameters in battery mode and for power restoration.

Click on the "Shutdown parameters" section in the menu to see the list of parameters.

Network Management Card

| UPS | Shutdown Parameters | | | Help |
|--|--|---|--|--|
| <ul style="list-style-type: none"> ● UPS Properties ● UPS Control ● Weekly Schedule ● Shutdown Parameters | Pulsar M 2200 | | | Computer Room |
| Logs and Notification <ul style="list-style-type: none"> ● Measurements ● Event Log ● System Log ● Email Notification | Output | On battery | System Shutdown | Restart |
| |  <input type="text" value="Master"/> | Shutdown if Remaining time under: <input type="text" value="180"/> sec if Capacity under: <input type="text" value="20"/> % <input type="checkbox"/> after: <input type="text" value="30"/> min | Shutdown duration : <input type="text" value="120"/> sec | If Capacity exceeds: <input type="text" value="15"/> % |
| |  <input type="text" value="Group1"/> | Switch Off after: <input type="text" value="900"/> sec if Capacity under: <input type="text" value="75"/> % | Shutdown duration : <input type="text" value="120"/> sec | Switch On after: <input type="text" value="30"/> sec |
| |  <input type="text" value="Group2"/> | Switch Off after: <input type="text" value="1800"/> sec if Capacity under: <input type="text" value="68"/> % | Shutdown duration : <input type="text" value="120"/> sec | Switch On after: <input type="text" value="18"/> sec |
| | <input checked="" type="checkbox"/> Show advanced parameters | | | |
| | Save modified settings : | | | <input type="button" value="Save"/> |

When you tick the Show advanced parameters option, extra parameters are displayed. These parameters enable, in particular, adjustment of certain thresholds related to the percentage of remaining battery charge level.

The Output column enables each outlet to be named (maximum 20 characters).

Note

As priority is given to the main outlet, the card cannot supply the controlled outlets when main outlet power is off.

For the main outlet ("Master" by default)

The first shutdown criteria initiates the restart of the [shutdown sequence](#).

- If remaining time is under (0 to 99999 seconds, 180 by default) is the minimum remaining backup time from which the shutdown sequence is launched.
- If battery capacity is under (0 to 100%); this value cannot be less than that of the UPS and is the minimum remaining battery capacity level from which the shutdown sequence is launched.
- Shutdown after (0 to 99999 minutes, not validated by default) is the operating time in minutes left for users after a switch to backup before starting the shutdown sequence.
- Shutdown duration (120 seconds by default) is the time required for complete shutdown of systems when a switch to backup time is long enough to trigger the shutdown sequences. It is calculated automatically at the maximum of Shutdown duration of subscribed clients but can be modified in the Advanced mode.
- If battery capacity exceeds Minimum battery level to reach before restarting the UPS after utility restoration

Important: Certain UPSs do not support this option

For the controlled outlets ("group 1 or group 2" by default)

The page enables programming of operation time and level in backup mode to manage outlet load shedding in the event of electric power failure:

- Switch Off after (from 0 to 99999, 65535 by default) defines the time during which the outlet is supplied starting from the moment of utility failure. Caution, this time includes the outlet shutdown duration.
- Switch Off if battery capacity under (0 by default) is an extra condition for outlet shutdown that can trigger the shutdown sequence before the shutdown duration runs out.
- Shutdown duration is the time required for complete shutdown of the systems supplied by the outlet when an outlet shutdown sequence is launched.
It is calculated automatically using the maximum shutdown durations of notified applications on the outlets.
- Switch On after (from 0 to 99999, default 65535) is the period between main output startup and startup of the relevant programmable outlet, therefore outlet startup can be delayed in relation to the main output.

Important: Certain UPSs do not support this option

Security: The administrator has to click on Save and enter his/her login/password to save any modifications. The login and password by default are: admin/admin

4.2.6 Measurements

Click on "*Measurements*" in the menu

- The next window shows the measurements for a mono phases UPS.

Network Management Card

The screenshot shows the 'Measurements' window for a 'Pulsar M 2200' UPS in a 'Computer Room'. The window has a 'Save Log' and 'Clear Log' button. Below the buttons is a table of measurements:

| Date | Time | AC Normal | | AC Output | | | | Battery | |
|------------|----------|-----------|-----------|-----------|-----------|-------------|---------------|-------------|--------------------|
| | | Voltage | Frequency | Voltage | Frequency | Power (kVA) | Load level(%) | Capacity(%) | Remaining time(mn) |
| 2008/06/12 | 17:56:47 | 241 | 50.0 | 231 | 50.0 | 0.1 | 2 | 99 | 125 |
| 2008/06/12 | 17:55:47 | 241 | 50.0 | 232 | 50.0 | 0.0 | 3 | 99 | 125 |
| 2008/06/12 | 17:54:47 | 242 | 50.0 | 230 | 50.0 | 0.0 | 2 | 99 | 125 |
| 2008/06/12 | 17:53:47 | 241 | 50.0 | 230 | 50.0 | 0.0 | 2 | 99 | 125 |
| 2008/06/12 | 17:52:47 | 241 | 50.0 | 231 | 50.0 | 0.0 | 2 | 99 | 111 |
| 2008/06/12 | 17:51:47 | 245 | 50.0 | 232 | 50.0 | 0.0 | 2 | 99 | 125 |
| 2008/06/12 | 17:50:47 | 243 | 50.0 | 231 | 50.0 | 0.0 | 2 | 99 | 125 |
| 2008/06/12 | 17:49:47 | 243 | 50.0 | 230 | 50.0 | 0.1 | 2 | 99 | 125 |
| 2008/06/12 | 17:48:47 | 243 | 50.0 | 231 | 50.0 | 0.0 | 2 | 98 | 124 |
| 2008/06/12 | 17:47:47 | 243 | 50.0 | 230 | 50.0 | 0.0 | 2 | 98 | 124 |
| 2008/06/12 | 17:46:47 | 243 | 50.0 | 231 | 50.0 | 0.0 | 2 | 98 | 124 |
| 2008/06/12 | 17:45:47 | 243 | 50.0 | 231 | 50.0 | 0.0 | 2 | 98 | 124 |
| 2008/06/12 | 17:44:47 | 243 | 50.0 | 230 | 50.0 | 0.0 | 2 | 98 | 124 |
| 2008/06/12 | 17:43:47 | 243 | 50.0 | 230 | 50.0 | 0.0 | 2 | 98 | 124 |
| 2008/06/12 | 17:42:47 | 243 | 50.0 | 230 | 50.0 | 0.1 | 2 | 98 | 124 |
| 2008/06/12 | 17:41:47 | 243 | 50.0 | 231 | 50.0 | 0.1 | 2 | 98 | 124 |
| 2008/06/12 | 17:40:47 | 243 | 50.0 | 231 | 50.0 | 0.0 | 2 | 98 | 124 |

The following measurements are saved and time-stamped (env. 430):

- "AC Normal : Voltage": Value of the utility voltage supplying the UPS
- "AC Normal : Frequency": Value of the utility frequency supplying the UPS
- "AC Output : Voltage": Value of the output voltage of your UPS
- "AC Output : Frequency": Value of the output frequency of your UPS
- "AC Output : Power (kVA)": Value of the output power of your UPS
- "AC Output : Load level (%)": Value of the percentage of load at UPS output
- "Battery : Capacity (%)": Percentage of charge available in the battery
- "Battery : Remaining time (mn)": Estimation of the remaining backup time
- The save frequency of these values is defined in the "[System](#)" page (60 seconds by default). Approximately 435 time-stamps are stored permanently on the card. The oldest time-stamps are automatically deleted.
- "Save Log" enables all saved values to be opened or saved in CSV format. (compatible with Excel type spreadsheets)
- "Clear Log" enables deletion of all records. Enter the login/password to validate this action.
-

4.2.7 Event log

- Click on **"Event Log"**. in the menu

Network Management Card

UPS

- UPS Properties
- UPS Control
- Weekly Schedule
- Shutdown Parameters

Event Log Help

Pulsar M 2200 Computer Room

| Date | Time | Event Description |
|------------|----------|---------------------------------------|
| 2008/06/12 | 18:03:43 | UPS on normal AC |
| 2008/06/12 | 18:03:43 | Normal AC OK |
| 2008/06/12 | 18:03:41 | Bypass AC voltage OK |
| 2008/06/12 | 18:03:41 | Normal AC voltage OK |
| 2008/06/12 | 18:01:11 | Bypass AC voltage out of tolerance |
| 2008/06/12 | 18:01:11 | Normal AC voltage out of tolerance |
| 2008/06/12 | 18:01:10 | Outlet group 2 shutdown in 28 mn 00 s |
| 2008/06/12 | 18:01:10 | Outlet group 1 shutdown in 13 mn 00 s |
| 2008/06/12 | 18:01:10 | System shutdown in 1 h 40 mn 20 s |
| 2008/06/12 | 18:01:09 | UPS on battery |
| 2008/06/12 | 18:01:09 | Normal AC NOK |

Logs and Notification

- Measurements
- **Event Log**
- System Log
- Email Notification

Settings

- Network
- System
- Notified Applications
- Access Control
- Time
- Firmware Upload

- **"Save log"** enables all saved values to be opened or saved in CSV format. (compatible with Excel type spreadsheets)
- **"Clear log"** enables deletion of all records. The administrator must enter his/her login / password to validate this action.

The card can save 435 events. The table of managed alarms is included in the [appendix](#).

4.2.8 System log

- Click on "System log". in the menu

Network Management Card

UPS

- UPS Properties
- UPS Control
- Weekly Schedule
- Shutdown Parameters

Logs and Notification

- Measurements
- Event Log
- **System Log**
- Email Notification

Settings

- Network
- System
- Notified Applications
- Access Control
- Time
- Firmware Upload

Help
Computer Room

System Log
Pulsar M 2200

| Date | Time | Event Description |
|------------|----------|---|
| 2008/06/13 | 11:16:05 | Environment sensor : Communication failure |
| 2008/06/13 | 11:15:01 | Network Management Card startup |
| 1970/01/01 | 00:00:00 | Time synchronized by NSM or EPM with 2008/06/13 11:13:50 [166.99.224.246] |

- "Save log" enables all saved values to be opened or saved in CSV format. (compatible with Excel type spreadsheets)
- "Clear log" enables deletion of all records. The administrator must enter his/her login / password to validate this action.

The card can save 435 events. The table of managed alarms is included in the [appendix](#).

4.3 Notification

4.3.1 Email Notification

The card offers the possibility of redirecting UPS alarms to an e-mail server. The format of these e-mails is compatible with mobile telephone transfer systems using text messages (SMS).

Network Management Card

UPS

- [UPS Properties](#)
- [UPS Control](#)
- [Weekly Schedule](#)
- [Shutdown Parameters](#)

Logs and Notification

- [Measurements](#)
- [Event Log](#)
- [System Log](#)
- [Email Notification](#)

Settings

- [Network](#)
- [System](#)
- [Notified Applications](#)
- [Access Control](#)
- [Time](#)
- [Firmware Upload](#)

Email Notification
Help

Pulsar M 2200
Computer Room

Recipient list

recipient1@domain.com
 recipient2@domain.com
 recipient3@domain.com
 recipient4@domain.com

Recipient :

▾

Attached files :

- Measurements
- Event Log
- System Log

Periodic report : Every day(s) at: ▾

day of next report: ▾

[Email Message Settings](#)
 Configure SMTP Server on
[Network Settings](#)

Notified events for the selected Recipient

Battery operation

- UPS on battery
- UPS on normal AC
- UPS Off sequence in progress
- Low battery

UPS alarms

- Battery fault
- Battery OK
- UPS overload
- UPS returns to normal load
- UPS fault
- UPS OK
- UPS communication failed
- UPS communication restored
- Charger fault
- Output on by-pass
- Return from by-pass

Software alarms

- Firmware upgrade

Network Management Card – User Manual

34003991EN/EC

Page 43/118

- **Recipient List:**

On the left side of this page, up to four recipients can be configured to receive e-mails from the card. Each addressee has its own trigger events, selected from the right side of the page, for which an e-mail is sent. The card's log indicates e-mail transmission errors.

Each recipient is configured with the following parameters:

- ▶ Recipient: (Field is limited to 99 characters) this is the e-mail address of the person or department to receive the e-mail.
The default value is recipientx@domain.com
- ▶ Attached files: The files selected (Measurements, Event log, System log, Environment measurements) are enclosed with each e-mail sent. The files are sent in CSV format
- ▶ Periodic report: In addition to the e-mails sent when events occur, a periodic e-mail containing the 3 log files can be sent to the recipient every x days at the time specified by the user.
To configure the first transmission, specify the day, time and frequency of the next transmission in the "next report" box. After this date, the page will show the date and time of the next transmission.
Data are sent in CSV format.

- **Save:** Saves any modifications.

- **Test** enables an e-mail to be sent to the recipient immediately. This is one way of checking e-mail transmission, particularly access to the SMTP server configured in "Network" settings. A transmission report is added to the system log.

The event label in the subject and text of the message is replaced with a test label.

If the user makes any modifications to the page, they must be saved before using the "Test" function.

- **Notified events:**

- The right side of the page shows the events that can be notified.

By default, only the main events of battery operation and a few UPS alarms are accessible. All the events appear if the Show/Hide Events option is actuated.

By default, two events are selected for notification. The user can modify this pre-selection by ticking other events or can, on the contrary, restore the initial configuration by clicking Set Default.

- **Email Message Settings:** access to the message configuration page

- **Network Settings:** enables the name of the SMTP server to be entered. [See page](#)

- **Security:** The administrator has to click on Save and enter his/her login/password to save any modifications. The default

login and password are: admin/admin

4.3.2 E-mail Message Settings

This page enables customisation of the content of the messages received by recipients of e-mails sent by the card. Customisation is common to the four recipients that can be notified (see [E-mail notification](#)).

Network Management Card

UPS

- UPS Properties
- UPS Control
- Weekly Schedule
- Shutdown Parameters

Logs and Notification

- Measurements
- Event Log
- System Log
- Email Notification

Settings

- Network
- System
- Notified Applications
- Access Control
- Time
- Firmware Upload

Email Message Settings Help

Pulsar M 2200 Computer Room

These settings are common for all the recipients, which can be notified by E-mail.

Sender :
ups@domain.com

Subject :
Network Management Card - <Event message>
Network Management Card

UPS Name
 UPS Location
 Event message

Message text :
Type here your own text

Save

- **Sender**
(59 characters maximum) identifies the source of the message. The default value is *ups@domain.com*. This field is free. However, depending on the type of SMTP server configuration, it is possible that the server checks that the domain name contained in the Sender address exists, and even that the user in the Sender address belongs to this domain.
- **Subject**
enables the user to specify the subject of the e-mail to be sent. By entering some free text and selecting from several optional fields, if desired, the message subject is built:
 - UPS name recalls the name of the UPS; it may or may not be selected.
 - UPS location recalls the geographic location of the UPS (see System Settings); it may or may not be selected.
 - Event message identifies the event generating the e-mail; it may or may not be selected.
- **Message text** is a free zone long of 255 characters maximum.

The body of the e-mail sent is composed of:

- Message text, which is free text.
- The date and time of the event, as saved in the log.
- URL of the card, enabling a direct link with the card to be established.
- Attachments, as configured for the e-mail recipients .- duplication of the subject, as configured.

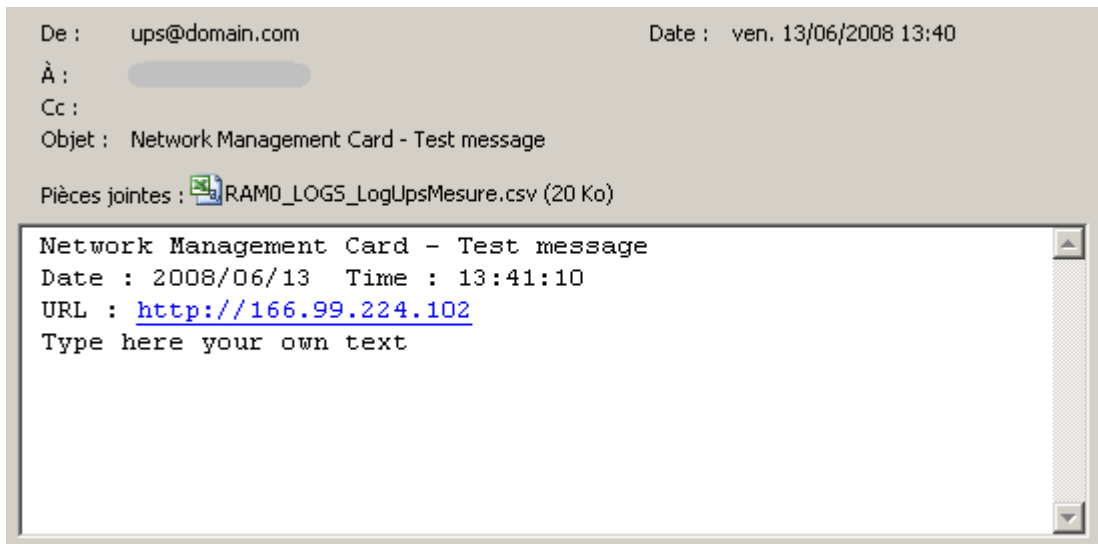

4.4 Configuration

The parameters of this menu can only be modified after entering the "Login" and "Password". The following screen is proposed automatically:



The default login and password are : admin/admin

Each field accepts up to 10 characters max.

After the login and password are entered, they remain active for 5 minutes.

If the browser is closed, they will have to be re-entered.

An error in either field results in systematic rejection of the requested action (save, page access, card reboot...). After three unsuccessful attempts, the browser must be rebooted.

These two fields do not travel "decoded" on the IT network. They are encrypted with an MD5 type algorithm, ensuring total confidentiality.

In the event of [password loss](#), the user can return to the default values via the maintenance menu.

4.4.1 Network settings

Click on "Network" in the menu.

This menu enables the administrator to configure the network parameters of the card and authorisation of the remote upgrade of the embedded system.

Network Management Card

| UPS | Network Settings | Help |
|--|--|---|
| <ul style="list-style-type: none">UPS PropertiesUPS ControlWeekly ScheduleShutdown Parameters | Pulsar M 2200 | Computer Room |
| Logs and Notification | IP address : | <input type="text" value="166.99.22.252"/> |
| <ul style="list-style-type: none">MeasurementsEvent LogSystem LogEmail Notification | Subnet Mask : | <input type="text" value="255.255.255.0"/> |
| Settings | Gateway Address : | <input type="text" value="166.99.17.1"/> |
| <ul style="list-style-type: none">NetworkSystemNotified ApplicationsAccess ControlTimeFirmware Upload | Hostname : | <input type="text"/> |
| | Domain Name : | <input type="text" value="ups.domain.com"/> |
| | BootP/DHCP : | <input type="text" value="Enabled"/> |
| | Firmware Upload : | <input type="text" value="Enabled"/> |
| | Primary DNS Server : | <input type="text" value="151.110.134.13"/> |
| | Secondary DNS Server : | <input type="text" value="151.110.134.17"/> |
| | SMTP Server (for Email Notification) : | <input type="text" value="smtpserver"/> |
| | Save modified settings : | <input type="button" value="Save"/> |

- **IP Address:** The IP address of the card (e.g.: 166.99.22.252).
- **Subnet Mask:** The mask of the sub-network of your network (e.g.: 255.255.255.0).
- **Gateway Address:** Indicate the IP address of the gateway to access the stations located outside the card's subnet (e.g.: 166.99.17.1).
- **Hostname** must be suited to the card. This is the first part of the fully qualified domain name, used by the DNS. As the card does not support NetBIOS protocol, the hostname will only be sent to DNS if the DHCP server sends it the hostname with the new IP address. This mechanism is described in the update of the DNS protocol [RFC 2136](#)
- **Domain Name** is the domain to which the card belongs. This is the part of the fully qualified domain name that follows the hostname and is used by the DNS. The default value of the two parameters comprising the fully qualified domain name: ups.domain.com
- **BOOTP/DHCP:** Authorises (choose "Enabled") configuration of network parameters with your BootP/DHCP server when the card is booted.

Mode of card operation with server: After each startup, the card makes 5 attempts to recover the network parameters. If no response is received from the server, the card boots with the last saved parameters from the previous start. These parameters are those shown on the page.

The default value for this parameter is "Enable"

Note 1:

If the hostname is not used, the IP address supplied by the DHCP server must be fixed to maintain connection with the clients installed on the stations to be protected.

Note 2:

During the first connection, if the DHCP query is not successful, the NMC starts with the following IP configuration:

IP address: 172.17.16.16

Subnet mask: 255.255.255.0

Gateway Address: 0.0.0.0

- **Firmware Upload:** Authorise (choose "Enabled") remote updating of the card's embedded software.
The default value for this parameter is "Enabled".
- **Primary DNS Server:** contains the IP address of the main DNS server ensuring conversion of the domain name to IP address.
- **Secondary DNS Server:** contains the IP address of the secondary DNS server ensuring conversion of the domain name to IP address if the primary DNS server is not available.
- **SMTP Server:** contains the name or IP address of the local server with which the card connects to send e-mails.
It may be filled in either as host + domain name (DNS resolution), or directly with the IP address.
The default value is smtpserver. The card uses the standard port (25) for sending e-mails.

Important note:

The card must be rebooted after any changes to these parameters.. [See "System" page](#)

Security: The administrator has to click on Save and enter his/her login/password to save any modifications.

4.4.2 System

Click on "System" in the menu.

This menu enables the customisation of the information on the [UPS properties](#) pages.

Network Management Card

| UPS | System Settings | Help |
|--|--|--|
| <ul style="list-style-type: none">UPS PropertiesUPS ControlWeekly ScheduleShutdown Parameters | Pulsar M 2200 | Computer Room |
| Logs and Notification <ul style="list-style-type: none">MeasurementsEvent LogSystem LogEmail Notification | UPS Contact : <input type="text" value="Computer Room Manager"/> | |
| | UPS Location : <input type="text" value="Computer Room"/> | |
| | Default Language : <input type="text" value="Auto"/> | |
| | History log interval (sec): <input type="text" value="60"/> | |
| | Environment log interval (sec): <input type="text" value="300"/> | |
| Settings <ul style="list-style-type: none">NetworkSystemNotified ApplicationsAccess ControlTimeFirmware Upload | Save modified settings : <input type="button" value="Save"/> | |
| | <input checked="" type="checkbox"/> Keep TCP/IP parameters | <input type="button" value="Reset Communication"/> |
| | | <input type="button" value="Factory Reset"/> |

- **UPS Contact:** This text field is limited to 49 characters. Enter the name of the person responsible for UPS administration at IT network level and/or electrical maintenance. This field does not appear on any other Web page. By default, its value is "Computer Room Manager".
- **UPS Location:** Enter a description (limited to 31 characters) of the location of the UPS in your installation (e.g. Computer room E1-C066). This text is displayed in the home page. By default, its value is "Computer Room".
- **Default Language:** Enables initialisation of the browser language at card connection. Choice of one of the available languages: English, French, German, Spanish, Italian changes the language of the html interface pages (reboot the browser after modification).
- **History log interval:** [from 5 to 99999 sec., 60 by default]. Measurement save period.
- **Environment log interval:** [from 60 to 99999 sec., 300 by default]. Temperature and humidity measurement save period. **Reset Communication button:** performs a remote reboot of the card without modifying the configuration. This action is compulsory for consideration of any changes made on the "Network Settings" page. Security of this operation is ensured by requesting Login and Password.

- **Factory Reset button:** enables restoration of the default configuration of all the card's parameters. TCP/IP parameters: IP address, subnet mask, gateway and BootP/DHCP value are maintained if the "Keep TCP/IP parameters" option is selected. Security of this operation is ensured by requesting Login and Password. The default login and password are : admin/admin

4.4.3 Notified Applications

Click on "*Notified Applications*" in the menu.

Security: The administrator has to enter his/her login/password in order to view this information.

This menu enables:

- The addition of the supervision stations receiving traps and configuration of the trap type.
- To list all the Notified Applications and the main parameters.
- To test the operation of notified applications
- by simulating power loss
- by sending a real shutdown sequence.

Network Management Card

The screenshot shows the 'Notified Applications' section of the Network Management Card. The interface includes a left sidebar with navigation menus (UPS, Logs and Notification, Settings) and a main content area with a table of notified applications and control buttons.

Notified Applications Help

Pulsar M 2200 Computer Room

| All | Nr | Hostname or IP Address | Application Name | Output | Configuration | Shutdown duration(sec) | Shutdown after (min) | Connected |
|--------------------------|----|------------------------|-----------------------|--------|---------------|------------------------|----------------------|-----------|
| <input type="checkbox"/> | 1 | grefrwe8000769 | Shutdown Module V3.10 | Master | CENTRALIZED | 120 | | |
| <input type="checkbox"/> | 2 | GREFRWC9976046 | Shutdown Module V3.10 | Master | CENTRALIZED | 120 | | |

Select the applications to be removed. Remove

Select the applications to be tested. Utility failure Test Shutdown Test

Select the Network-Management-System to be modified. Modify NMS Add NMS

Up to 100 destinations can be managed by the card :

- 35 in TCP connected mode or
- 100 in UDP not connected mode or
- mixed mode: 20 connected and 50 not connected.

Important note: It is not necessary to add the Network Shutdown Modules protecting your servers in this list. These modules subscribe and unsubscribe themselves automatically.

Select an entry in the list to modify the values in the edit zone at the bottom of the page. The table displays the following information:

- The All button: Allows the following information to be displayed.
- **Nr** is the index where the application is stored into the table.
- **Hostname or Address IP:** By priority, the hostname of the computer is displayed when the IP address can be converted into a hostname by a DNS server or if the application has been entered as a hostname.
- **Application Name :** Gived by the application at subscription time.
- **Output:** number of the UPS output from which the client is powered.
- **Configuration:** shows where the parameters of the Network Shutdown Module come from: Local (coming from the

application) or Central (coming from the card).

The [Central shutdown configuration](#) is available by clicking on the Configuration link.

- **Shutdown duration:** the shutdown duration necessary to properly shutdown the computer.
- **Shutdown after:** the time available to the user from the power failure until the launch of the shutoff sequence of the UPS and equipment This parameter is optional.

Many actions are available on this page:

- **Remove:** Depending on the kind of application, the selected ones will definitively disappear from the table as SNMP applications, or they will disappear and automatically re-subscribe as Network Shutdown Module applications.
 - **Utility failure Test:** Two alarms, 'Utility failure' and 'Utility restored' spaced 60 seconds apart, will be sent to the applications selected, making sure that the applications can be reached over the network.
 - **Shutdown Test:** This test simulates a UPS on battery operation. It enables an easy check to see if the server protection works correctly.
 - No intervention on the UPS is required.
- The applications selected will process the simultaneous alarms and perform an actual shutdown sequence.

WARNING!

- This test will generate a REAL shutdown sequence of the selected servers on which the Network Shutdown Module application is running.

- **Add NMS:** allows an SNMP trap receiver to be added such as a Network Management System.
- **Modify NMS:** allows an SNMP trap receiver to be modified.

Both buttons open a new window where it is possible to enter the Application name, the Hostname or IP Address, the Trap community and the severity.

Network Management Card

| | |
|--|--|
| UPS | Network Management System |
| <ul style="list-style-type: none">● UPS Properties● UPS Control● Weekly Schedule● Shutdown Parameters | Pulsar M 2200 Computer Room |
| Logs and Notification | Application Name : <input type="text"/> |
| <ul style="list-style-type: none">● Measurements● Event Log● System Log● Email Notification | Hostname or IP address : <input type="text"/> |
| Settings | Protocol : SNMP V1 |
| <ul style="list-style-type: none">● Network● System● Notified Applications● Access Control● Time● Firmware Upload | Trap Community : <input type="text"/> |
| | Severity : 1 - Warning ▼ |
| | <input type="button" value="Cancel"/> <input type="button" value="Save"/> |

The default severity value is 1 – Warning

4.4.4 Central shutdown configuration

Click on "Notified Applications" in the menu, then "Configuration".

Network Management Card

| UPS | Central shutdown configuration | Help | | | | | | |
|--|---|--|---------------------------------|----------------------------------|---------------------|----------------------------------|-----|--|
| <ul style="list-style-type: none">UPS PropertiesUPS ControlWeekly ScheduleShutdown Parameters | <p>Pulsar M 2200</p> <p>This configuration will be used by the Network-Shutdown-Modules, on next connection.</p> | Computer Room | | | | | | |
| Logs and Notification | Shutdown Parameters | | | | | | | |
| <ul style="list-style-type: none">MeasurementsEvent LogSystem LogEmail Notification | <table border="1"><tr><td><input type="checkbox"/> Shutdown after:</td><td><input type="text" value="30"/></td><td>min</td><td>Shutdown duration :</td><td><input type="text" value="120"/></td><td>sec</td></tr></table> | <input type="checkbox"/> Shutdown after: | <input type="text" value="30"/> | min | Shutdown duration : | <input type="text" value="120"/> | sec | |
| <input type="checkbox"/> Shutdown after: | <input type="text" value="30"/> | min | Shutdown duration : | <input type="text" value="120"/> | sec | | | |
| Settings | Broadcast | | | | | | | |
| <ul style="list-style-type: none">NetworkSystemNotified ApplicationsAccess ControlTimeFirmware Upload | <ul style="list-style-type: none"><input checked="" type="checkbox"/> Administrators<input checked="" type="checkbox"/> Users | | | | | | | |
| | <input type="button" value="Save"/> | | | | | | | |

This page is used to define either the "shutdown" or the "notification" settings used by the Network Shutdown Modules that connect to Network Management Card. These settings are used by the Network Shutdown Modules if they are in central-configuration mode or if their configuration is not valid.

- **Shutdown duration:** the shutdown duration necessary to properly shutdown the computer.
- **Shutdown after:** the time available to the user from the power failure until the launch of the shutoff sequence of the UPS and equipment. This parameter is optional. Uncheck the box if you wish not to use this parameter.
- **Broadcast :** Sends network notifications to the Administrators and Users groups on events declared in the server hosting the NSM

If you wish to set up a new configuration for the Network Shutdown Modules already set to "central-configuration mode", proceed as indicated below:

- Change the Network Shutdown Module parameters in the "Notified Applications" page.
- Click the "Save" button.
- In this page, select the NSMs for which you want to apply the new configuration.
- Press the "Remove" button.
- The NSMs selected will disconnect then reconnect and use the new configuration.

4.4.5 Access control

Click on "Access Control" in the menu.

To access this page, the login and password are systematically requested if they have not already been entered. This menu enables configuration of the different parameters enabling secure access to the card via a browser or SNMP.

Network Management Card

| UPS | Access Control | Help |
|--|----------------------------------|---|
| <ul style="list-style-type: none">UPS PropertiesUPS ControlWeekly ScheduleShutdown Parameters | Pulsar M 2200 | Computer Room |
| Logs and Notification | Enter New Manager Login : | <input type="text" value="admin"/> |
| <ul style="list-style-type: none">MeasurementsEvent LogSystem LogEmail Notification | Enter New Password : | <input type="password" value="....."/> |
| Settings | Confirm New Password : | <input type="password" value="....."/> |
| <ul style="list-style-type: none">NetworkSystemNotified ApplicationsAccess ControlTimeFirmware Upload | Current Community Read-Only is : | public |
| | Change Community Read-Only : | <input type="text" value="public"/> |
| | Security mode : | <input checked="" type="radio"/> Authentication for configuration |
| | | <input type="radio"/> Full authentication |
| | | <input type="radio"/> SSL and full authentication |
| | Save modified settings : | <input type="button" value="Save"/> |

- **Login:** This text field is limited to 10 characters - Enables secure access and modification of pages. Default value "admin"
- **Change / Confirm password:** This text field is limited to 10 characters - Enables secure access to Configuration menu pages. Default value "admin"
- **Current Community Read name:** Indicates the SNMP community name used for read operations
- **Change Community Read-Only:** This text field is limited to 49 characters - Enables the SNMP community name used for read operations to be changed
- **Security mode:** manages the various authentication methods for page access
- **Authentication for configuration:** Only the configuration pages are protected by login / password
- **Full authentication:** All pages are protected by login / password
- **SSL and full authentication:** All pages are protected by login / password and are only accessible in SSL

- **SSL Access:** When selected, access to the Web interface is made in secure mode (https).
Connections with Network Shutdown Modules stay in standard mode (secure TCP)

SSL Security Implementation:

SSL → version 3.0
TLS → version 1.0
Method → TLS_RSA_WITH_512_MD5
Auth → RSA
Key Exchange → RSA
Encryption → RC4_512
Digest → MD5

Changes take effect after a card reboot

4.4.6 Date and time

Click on "*Date and Time*" in the menu.

This menu enables initialisation of the date and time of the card in three different ways.

The date format is always of year/month/day type

Network Management Card

The screenshot shows the 'Setting time' configuration page for a Pulsar M 2200 UPS. The page is divided into a sidebar menu and a main configuration area. The sidebar menu includes sections for 'UPS', 'Logs and Notification', and 'Settings'. The main configuration area is titled 'Setting time' and includes a 'Help' link and 'Computer Room' label. It shows the 'Current date and time' as 2008/06/13 and 14:38:44. There are two radio buttons for setting the time: 'Set manually' (unselected) and 'Accept automatic update from NSM or EPM' (selected). The 'Set manually' section has input fields for 'Date (yyyy/mm/dd):' (2008/06/13) and 'Time (hh:mm:ss):' (14:38:44). The 'Accept automatic update from NSM or EPM' section has a radio button that is selected. The 'Synchronize with NTP server' section has a radio button that is unselected. Below this, there are input fields for 'Hostname:' (ntpserver) and 'Time-Zone:' ((GMT) Casablanca, Greenwich Mean TIME : Dublin, Lisbon, London). There is also a checkbox for 'European Daylight Savings Time' which is unselected. At the bottom, there is a 'Save modified settings:' label and a 'Save' button.

- **Set manually:** Enables initialisation of the date and time of the card, with the values entered in the Date and Time fields. This update is made after clicking on the "Save" button.
Maximum drift is +/- 2 min./month
- **Accept automatic update from NSM or EPM:** Enables initialisation of the date and time of the card, with the values provide by the Network Shutdown Modules or the Enterprise Power Management.

- **Synchronize with NTP server:** Enables connection with a time server, either available on the company's internal network or on the Web. This server communicates GMT time. The IP address or hostname of the time server must be entered, and the time zone of your geographic area must then be selected from the list. Connection is made with the server and the date and time are set after clicking on the "Save" button. Time is updated every five hours, thus preventing any drift in the time. After two attempts, if the NTP server is not accessible, the card shifts to manual mode.
The card uses the NTP protocol (UDP 123 port). The "firewall" must be set to transmit queries outside the intranet. No error message is generated if the time server contact fails.

Note 1:

The even the card is used in a UPS supporting time-stamping, the card's time is automatically synchronized with that of the UPS.

Note 2:

After start-up, if the card is in manual mode or if no NTP server was reached, the card initializes at 01/01/1970

4.4.7 Firmware upload

Click on "*Firmware Upload*" in the menu.

This menu enables a new firmware version to be uploaded

Network Management Card

The screenshot shows the Network Management Card interface. On the left, there is a navigation menu with three sections: **UPS** (containing UPS Properties, UPS Control, Weekly Schedule, and Shutdown Parameters), **Logs and Notification** (containing Measurements, Event Log, System Log, and Email Notification), and **Settings** (containing Network, System, Notified Applications, Access Control, Time, and Firmware Upload). The **Firmware Upload** option is highlighted in blue. The main content area is titled "Firmware Upload" and includes a "Help" link. Below the title, it displays "Pulsar M 2200" and "Computer Room". A section labeled "Firmware to Upload :" contains a file input field, a "Parcourir..." button, and an "Upload" button. A warning message states: "WARNING: This action takes a few minutes. Don't click on any button or item during this operation."

To upload a new version of the card's firmware, select the file to be loaded using the "Browse..." button and click **Upload**.

Do not interrupt the operation before the card displays the following screen:

Network Management Card

This screenshot shows the same Network Management Card interface as the previous one, but with a success message. The "Firmware Upload" option in the left menu is still highlighted. The main content area shows the same "Firmware Upload" section, but now includes a green success message: "SUCCESS : Firmware was successfully written in FLASH. Restart in progress. Wait a few minutes and click on Refresh button."

4.5 Environment Sensor (option)

The environment sensor (66846) is an option that enables temperature and humidity to be measured, and indication of the position of two external contacts. It is connected with a standard network cable to the Card Settings port of the Network Management Card.

The card automatically detects sensor presence. The main menu then displays an additional section "Environment" with the following elements:

- Status
- Configuration
- Log

Important note: To switch the serial port to the configuration mode, just disconnect the cable and [reset the card](#).

4.5.1 Characteristics

- Temperature measurement from 0 to 70 °C with +/- 1° C accuracy
- Measurement of humidity from 0 to 100% with +/- 6% accuracy
- Min / max time-stamped function for temperature and humidity
- Choice of temperature readings in Celsius or Fahrenheit
- High and low thresholds, hysteresis and offset adjustable via Web interface
- Possibility of notification of status changes by e-mail, SMS or SNMP trap
- Position detection of 2 dry contacts (maximum sensor/contact distance: 20 m)
- Name and status of each configurable contact
- Recording of events and measurements in the card log
- Possibility of shutting down the installation safely if one of the thresholds is exceeded or dry contact status change
- Connection to the Network Management Card by CAT5 straight RJ45 network cables (maximum card/sensor distance: 20m)

4.5.2 Environment Status

Network Management Card

UPS

- UPS Properties
- UPS Control
- Weekly Schedule
- Shutdown Parameters

Logs and Notification

- Measurements
- Event Log
- System Log
- Email Notification

Settings

- Network
- System
- Notified Applications
- Access Control
- Time
- Firmware Upload

Environment

- Status
- Settings
- Log

Environment Status Help

Pulsar M 2200 Computer Room

Temperature

0 22.5 °C 70

Min: 20.7 recorded on 2008/06/13 11:10:40
Max: 23.2 recorded on 2008/06/13 14:53:42

Reset Min/Max Calibrate [Configure thresholds on Environment Settings](#)

Humidity

0 % 34.9 % 100 %

Min: 34.0 % recorded on 2008/06/13 14:54:54
Max: 53.3 % recorded on 2008/06/13 11:10:40

Reset Min/Max Calibrate [Configure thresholds on Environment Settings](#)

Input #1

2008/06/13 14:47:41 Input #1 open

Input #2

2008/06/13 14:51:59 Input #2 open

For both measurements, a graduated gauge proposes the following functions:

The cursor indicates the current value.

Two red zones to the left and right represent the high and low thresholds that can be set on the Environment Settings page.

When the measured value enters one of these zones, an alarm can be notified (see Notification parameter in the Environment Settings page).

Time-stamped minimum and maximum temperatures show the extreme values recorded since the last Reset Min/Max, a thin dotted line shows their positions on the gauge.

Min and Max can be forced at any time to the current value by clicking on the Reset Min/Max button.

Calibrate: The sensor is factory-calibrated, but the user can apply an offset to adjust the measurement.

Input #1 and Input #2 show the position of the two contacts acquired by the sensor.

The position is displayed with the parameters entered in the Environment Settings page.

The last status change of each contact is time-stamped.

The Internet browser updates this page every 10 seconds

4.5.3 Environment Settings

Network Management Card

UPS

- UPS Properties
- UPS Control
- Weekly Schedule
- Shutdown Parameters

Logs and Notification

- Measurements
- Event Log
- System Log
- Email Notification

Settings

- Network
- System
- Notified Applications
- Access Control
- Time
- Firmware Upload

Environment

- Status
- Settings
- Log

| Environment Settings | | | | Help |
|--|--|--------------------|--------------------------|-------------------------------------|
| Pulsar M 2200 | | | Computer Room | |
| Sensor name: | Environment sensor | | Notification | System Shutdown |
| Temperature | High threshold: | 40 | <input type="checkbox"/> | <input type="checkbox"/> |
| | <div style="display: flex; align-items: center;"> <div style="border: 1px solid black; padding: 2px; margin-right: 5px;">°C</div> <div style="flex-grow: 1;">Low threshold:</div> </div> | 5 | <input type="checkbox"/> | <input type="checkbox"/> |
| | Hysteresis: | 2 | | |
| Humidity | High threshold: | 90 % | <input type="checkbox"/> | <input type="checkbox"/> |
| | Low threshold: | 5 % | <input type="checkbox"/> | <input type="checkbox"/> |
| | Hysteresis: | 5 % | | |
| Input #1: | Input #1 | closed when closed | <input type="checkbox"/> | <input type="checkbox"/> |
| | | open when open | <input type="checkbox"/> | <input type="checkbox"/> |
| Input #2: | Input #2 | closed when closed | <input type="checkbox"/> | <input type="checkbox"/> |
| | | open when open | <input type="checkbox"/> | <input type="checkbox"/> |
| <input checked="" type="checkbox"/> Show advanced parameters | | | | |
| Save modified settings : | | | | <input type="button" value="Save"/> |

The environment sensor measures temperature, humidity and gives the status of the 2 contacts (used for door, alarms or generator unit).

The temperature and humidity thresholds can be adjusted and can trigger notification and correct shutdown of the protected system.

The Sensor name is the function name given to the sensor, usually it enables location of the sensor.

Temperature: Choose the temperature unit (°C or °F) from the selection box.

High threshold: if this value is exceeded, a notification if enabled. The default value is 40 °C / 104 °F.

Low threshold: If this value is exceeded, a notification if enabled. The default value is 5 °C / 41 °F .

Hysteresis must be set to prevent multiple notifications if temperature fluctuates around a threshold.

The default value is 2 °C / -3.6 °F.

The high alarm disappears when the value drops below the High threshold - Hysteresis value

The low alarm disappears when the value returns above the Low threshold + Hysteresis value

Humidity

High threshold: If this value is exceeded, a notification is sent if this is validated. The default value is 90%.

Low threshold: If this value is exceeded, a notification is sent if this is validated. The default value is 5%.

Hysteresis must be set to prevent multiple notifications if humidity fluctuates around a threshold. The default value is 5%.

The high alarm disappears when the value drops below the High threshold - Hysteresis value

The low alarm disappears when the value returns above the Low threshold + Hysteresis value

Input #1 and Input #2: Enter an identifier corresponding to the acquired contact (e.g.: rack door, air conditioning, generator unit, etc.). Max. length is 28 characters.

when closed and when open: are the names associated to the two contact positions. (e.g.: "open" and "closed" for a door, "On" and "Off" for a generator).

Each status change triggers a notification if enabled.

When the Notification box is enabled, the following functions are activated for each event selected:

- display in the [list of current alarms](#)
- Consideration in the [UPS log](#)
- SNMP trap generation
- notification by e-mail (if the Environment sensor notification option is enabled in the [e-mail notification](#) page)

The list of messages is given in the [appendix](#)

System shutdown can be triggered for each notification if this option is enabled. If notification is disabled, the Shutdown option cannot be used.

Export settings to file: Enables exportation ("Download" button) and saving of card configuration information.

Import settings from file: Enables selection of a configuration file ("Browse" button) and uploading ("Upload" button) of card configuration information.

Security: The user must be identified to access this page.

4.5.4 Log

Network Management Card

UPS

- UPS Properties
- UPS Control
- Weekly Schedule
- Shutdown Parameters

Logs and Notification

- Measurements
- Event Log
- System Log
- Email Notification

Settings

- Network
- System
- Notified Applications
- Access Control
- Time
- Firmware Upload

Environment

- Status
- Settings
- Log

Help

Environment Log Data

Pulsar M 2200 **Computer Room**

| Date | Time | Temperature (°C) | Humidity (%) |
|------------|----------|------------------|--------------|
| 2008/06/13 | 16:03:53 | 22.1 | 35.7 |
| 2008/06/13 | 15:58:45 | 22.2 | 35.4 |
| 2008/06/13 | 15:53:36 | 22.2 | 36.1 |
| 2008/06/13 | 15:48:27 | 22.1 | 35.6 |
| 2008/06/13 | 15:43:18 | 22.1 | 36.0 |
| 2008/06/13 | 15:38:10 | 22.1 | 35.8 |
| 2008/06/13 | 15:33:01 | 22.0 | 35.3 |
| 2008/06/13 | 15:27:52 | 22.1 | 35.7 |
| 2008/06/13 | 15:22:43 | 22.1 | 35.3 |
| 2008/06/13 | 15:17:35 | 22.1 | 35.2 |
| 2008/06/13 | 15:12:26 | 22.1 | 35.1 |
| 2008/06/13 | 15:07:17 | 22.2 | 34.8 |
| 2008/06/13 | 15:02:08 | 22.5 | 34.9 |
| 2008/06/13 | 14:57:00 | 22.9 | 34.3 |
| 2008/06/13 | 14:51:51 | 22.7 | 36.7 |
| 2008/06/13 | 14:46:42 | 21.4 | 36.6 |

The two environment sensor measurements: Temperature and Humidity are recorded at an interval defined by the Environment log interval in the [System settings](#) page.

By default, this period is 300 seconds.

Each measurement is dated and stored in the log of the UPS's communication card.

The size of log files is limited by a time indexing system.

The user can Save the log on his/her workstation at any time, in a CSV format file.

The user can also Clear the files contained in the card to reset the log.

5 Server protection

5.1 Set-up of the shutdown parameters

The protection application : Network Shutdown Module or Netwatch, on protected server boot, subscribes itself automatically to [notified applications](#) list and sends its essential data:

- IP Address or hostname of the server on which it is installed: So that the card can inform it of power events.
- Time required to shutdown the server (Shutdown Duration, configurable in the "Set-up" menu of each NSM): The card takes into account the longest shutdown time of all the Network Shutdown Modules subscribed (This is the Shutdown duration of the [Shutdown parameters](#)) page to manage UPS shutdowns without affecting any of Shutdown Modules connected.

During normal operation, the protection application periodically checks its connection with the card.

In case of a major power event, the card sends information to the protection application which reacts according to the situation. (shutdown order, programmed actions, messages to the administrator and to users via the network)

When the server shuts down, the protection application unsubscribes itself from the [notified applications](#).

5.1.1 Shutdown criteria managed by the Network Management Card

During an extended power failure, three criteria may cause the server shutdown procedure to be initiated. If several criteria are selected, (See page [Shutdown parameters](#)), the first criterion encountered will launch the shutdown procedure.

At the end of the shutdown procedure, when all servers have been shut down, the UPS may shut down to avoid unnecessary discharge of its batteries, depending on its configuration.

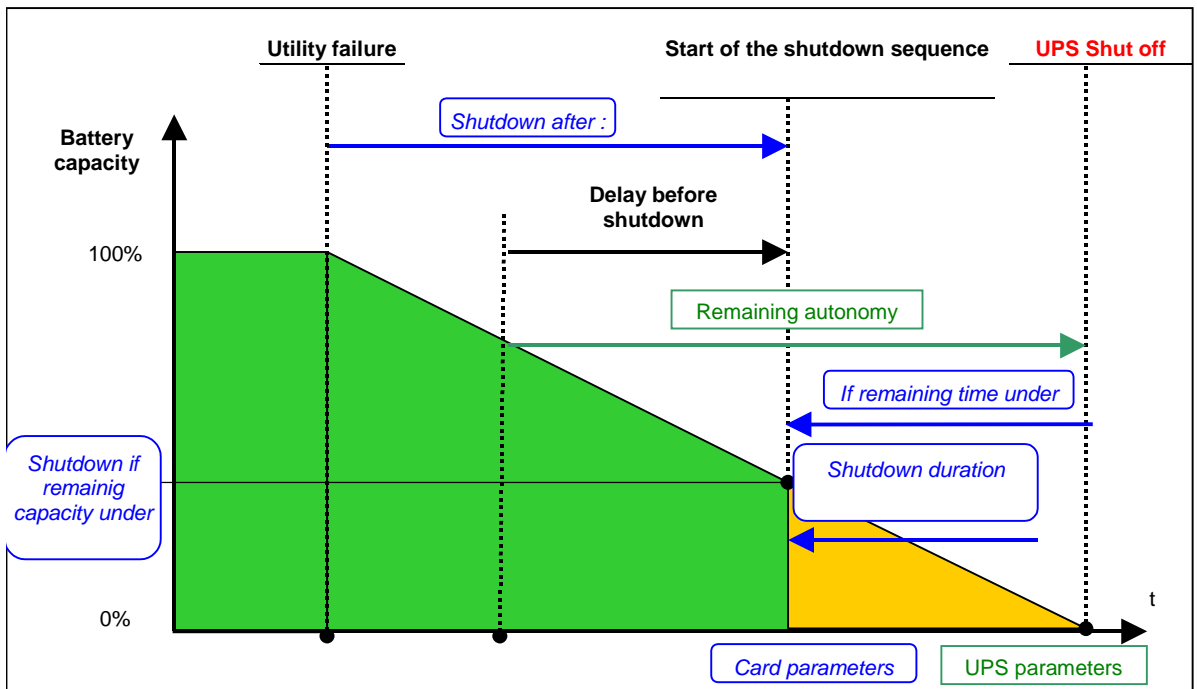

5.1.1.1 Backup time before initiating the shutdown procedure (Shutdown After – Shutdown Timer)

When the UPS switches to battery, the Network Management Card starts the Shutdown Timer countdown and launches the system shutdown procedure at the end of the countdown.

This value must be chosen so that users have time to complete their tasks and disconnect, without exceeding battery backup time.

Note 1:

The Network Shutdown Module can also manage its own Shutdown Timer (configurable in the Shutdown Module "set-up" menu of each Network Shutdown Module) launched when the UPS switches to battery.

Note that if this criterion is selected to initiate system shutdown, automatic system reboot when power is restored is not guaranteed (e.g. power restoration if only this system was shut down).

5.1.1.2 Initiating the shutdown procedure when the battery level is lower than: (If Capacity under)

When the card detects that the remaining backup time percentage is less than the configured level, the shutdown sequence is started.

By default, this value is set at 20%.

Note:

The UPS already manages an equivalent parameter for the end of backup pre-alarm.

The card does not accept values less than that programmed in the UPS.

Check the UPS documentation.

5.1.1.3 Shutdown when backup time is less than

When the Network Management Card detects that the percentage of backup time remaining is less than the value set, the shutdown sequence is started.

5.1.1.4 Shutdown duration

Duration (in seconds) required for the system protected by the protection application to shut down.

The protection application transmit their own "Shutdown duration" to the Network Management Card.

Based on these values (maximum Shutdown duration of all subscribed customer systems) that the card will send to the delayed shutdown order to the UPS.

5.1.2 Controlled outlets

Certain UPS models are equipped with controlled outlets (generally 2) which are always dependant on the UPS's main outlet.

Shutdown of the main outlet systematically causes shutdown of the programmable outlets.

The following notations are used to identify these outlets:

- Main outlet: Main
- Controlled outlet 1 1
- Controlled outlet 2 2

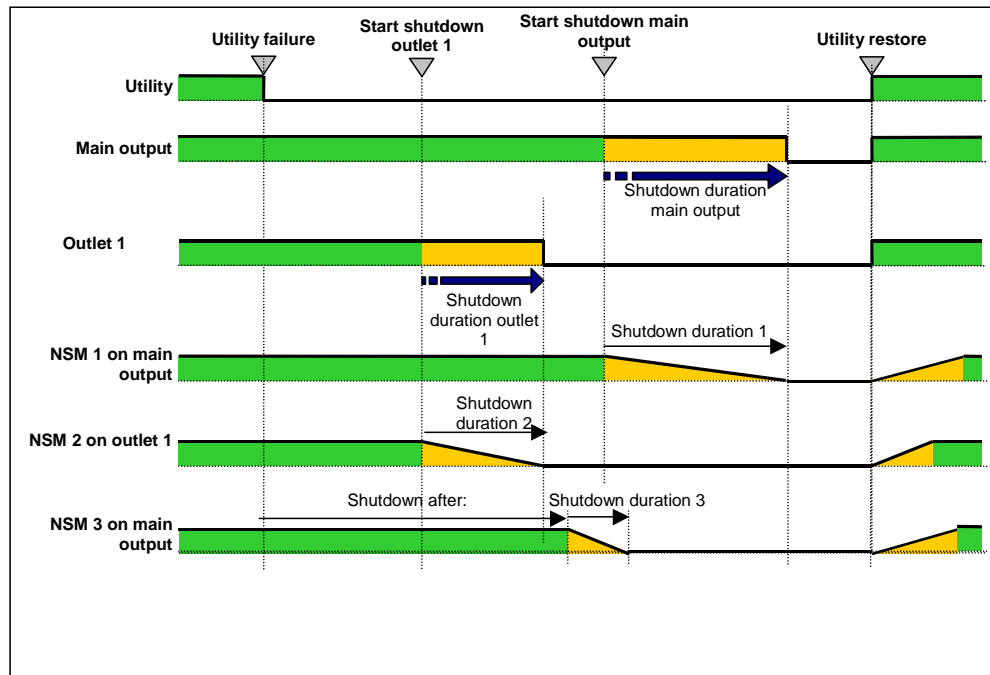

5.1.3 Protection of a server connected to a controlled outlet

Network Shutdown Modules (NSM) starting with version 3.0 are compatible with the controlled outlets.

After connecting the server electrically to one of the controlled outlets, the NSM must be informed of the outlet number to which it is connected.

Refer to the documentation of the NSM available on the internet site www.eaton.com section "[Downloads – Software Download](#)".

5.1.3.1 Load shedding or sequential shutdown

It is possible to optimise backup time by shutting down non-priority equipment or sequencing the shutdown of several devices.

Two shutdown criteria are possible:

- Shutdown of outlets after a set battery back-up time (After)
- Shutdown of outlets at a given battery discharge level (if battery capacity under)

It is possible to specify values for both criteria. The first criterion reached will initiate server shutdown.

5.1.3.2 Sequential startup

It is possible to delay outlet power-on to reduce inrush currents on startup or to sequence the startup of several devices.

Controlled outlet startup after a given time is based on startup of the main outlet.

5.2 The different server and UPS shutdown sequences

5.2.1 Extended power outage, shutdown initiated by the Shutdown Timer (Shutdown after)

During battery backup time, the Shutdown Timer of the Network Management Card is reached: After a user-defined backup time period ([Shutdown parameters](#) page), the shutdown of all servers is initiated, followed by the UPS shutdown (depending on its configuration). The UPS restarts when utility power is restored (depending on its configuration)

Shutdown duration: Maximum value of shutdown times of protection application subscribed to the card. This value is updated each time a client subscribes/ unsubscribes.

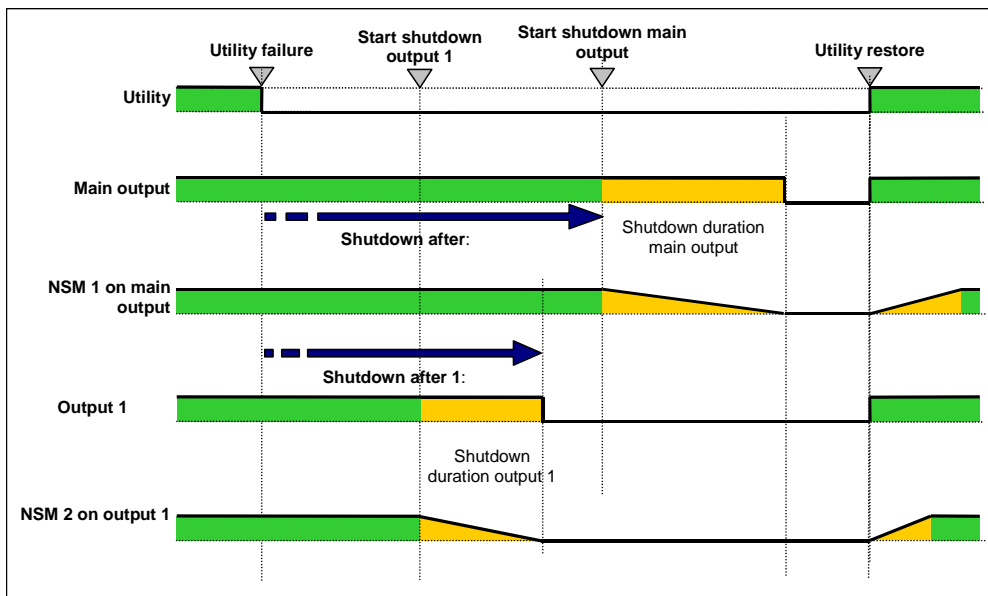

5.2.2 Extended power outage, shutdown initiated by the "Low battery power" message

When the "Low battery power" criterion is displayed, the UPS is shut off after taking into account the shutdown duration of the servers.

"Low battery power": The message appears if either of the two following criteria is checked:

- Low Battery Level
- Low Battery Delay

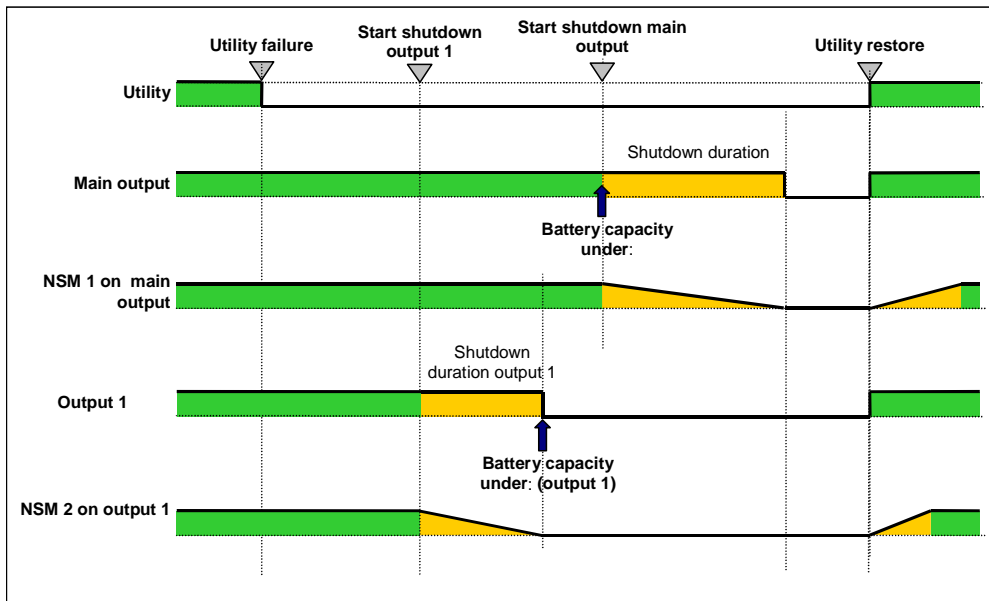

5.2.3 Case of power restoration before the end of the "shutdown duration" counter

If power is restored before the end of the Shutdown Duration, the UPS is shut off after the Shutdown Duration for a time equal to the forced reboot delay (10 seconds)

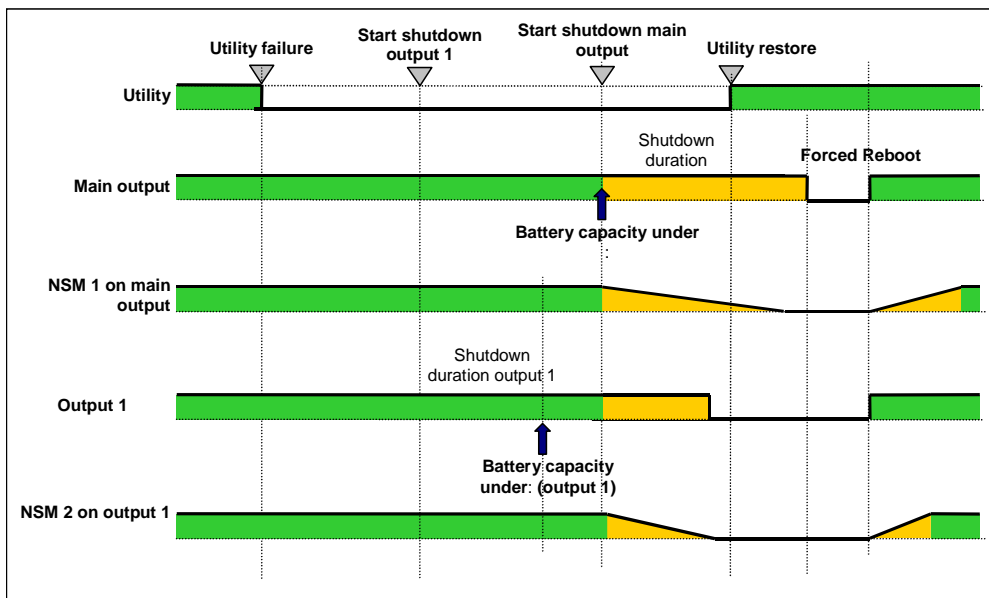

5.3 Shutdown management with 2 NMC boards

Certain UPS can have 2 NMC boards in order to:

- Increase the number of protected servers,
- Protect 2 groups of server connected to different networks physically separated.

5.3.1 Shutdown Duration

As described in the 5.1.1.4 paragraph, The protection application transmit their own "Shutdown duration" to the Network Management Card. Based on these values (maximum Shutdown duration of all subscribed customer systems) that the card will send to the delayed shutdown order to the UPS.

If the UPS have two NMC cards, the maximum shutdown duration of the two groups of protected systems will be used for the delayed shutdown order.

Example: If the subscribed customers of the first NMC card have a maximum Shutdown duration of 60s and the ones of the second NMC card of 120s, the servers shutdown will be launched 120s before the UPS shutoff..

5.3.2 Settings

Set-up shutdown parameters to the same values on the 2 cards is highly recommended (for the main output and the controlled outlets).

If the settings are not the same, the first criteria reached on one the 2 cards will launch the secure shutdown of all servers

Please, note that in any case the shutdown of the protected servers will be executed safely.

6 Configuration via RS232

- Use the cord supplied with the card.

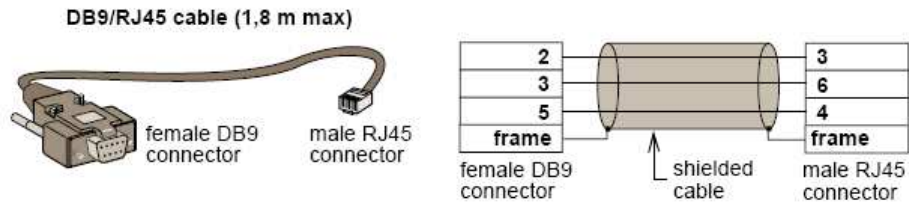

- Connect the card to a computer equipped with a hyperterminal type emulator. The serial link must be set at 9600 baud, 8 bits, no parity, 1 stop bit, and without flow control.
- Check that UPS power is on.
- Enter the admin password (not modifiable).
- The menu is in English only.

EATON
NETWORK MANAGEMENT CARD

1 : Reset
2 : Network configuration
3 : Set Login Password to Default
4 : Return to Default Configuration
0 : Exit

6.1 Choice 1: Restart / Reset

Use this function to restart the card; two choices are possible

1 : Hardware Reset: Equivalent to a restart of the electrical power supply.

2 : Restart application: Restarts only the application part.

```
-----  
Reset  
-----  
1 : Hardware Reset  
2 : Restart application  
0 : Exit  
-----
```

6.2 Choice 2: Network Configuration

Use this function to access network settings.

```
-----  
Network settings  
-----  
1 : Read Network settings  
2 : Modify Network settings  
3 : Set Ethernet speed  
0 : Exit  
-----
```

6.2.1 Choice 1: Read Network settings

Enables reading of the card's routine settings

```
Network configuration :  
MAC address : 00:20:85:FD:1C:07  
Mode : Static IP  
IP address : 166.99.18.129  
Subnet mask : 255.255.248.0  
Gateway : 166.99.17.1
```

6.2.2 Choice 2: Modify Network settings

Enables the modification of network parameters

For each of the following questions, you can press <Return> to select the value shown in braces, or you can enter a new value.
Should this target obtain IP settings from the network?[N]
Static IP address [166.99.18.129]?
Subnet Mask IP address [255.255.248.0]?
Gateway address IP address [166.99.17.1]?
Wait during your new configuration is saved ...
Reset the card to take into account the new configuration.

In DHCP mode, the card can receive the following parameters according to the DHCP server settings

- IP address
- Subnet Mask
- Gateway address
- Primary DNS server
- Secondary DNS server

The card must be [restarted](#) in order for the new parameters to be taken into account.

6.2.3 Choice 3: Set Ethernet speed

Enables the modification of the network speed

Set the Ethernet speed : [1 : Automatic, 2 : 10 MBit]
1
New Ethernet speed : Automatic
Wait during the new setting is saved ...
Reset the card to take into account the new configuration.

The card must be [restarted](#) in order for the new parameters to be taken into account.

6.3 Choice 3: Lost password / Set Login Password to Default

In the even the login or password is lost, choice 3 enables the return to the default password:

```
-----  
EATON  
NETWORK MANAGEMENT CARD  
-----  
1 : Reset  
2 : Network configuration  
3 : Set Login Password to Default  
4 : Return to Default Configuration  
0 : Exit  
-----  
Wait during Login Password return to default ...
```

Wait for the confirmation message.

```
Login Password are sucefully been set.
```

The card is now accessible via the Web with the password admin.

The card must be [restarted](#) in order for the new parameters to be taken into account.

6.4 Choice 4: Return to Default Configuration

Enables restoration of the [default configuration](#) of all the card's parameters

```
-----  
EATON  
NETWORK MANAGEMENT CARD  
-----  
1 : Reset  
2 : Network configuration  
3 : Set Login Password to Default  
4 : Return to Default Configuration  
0 : Exit  
-----  
Wait during configuration returns to default ...
```

Wait for the confirmation message.

```
Configuration has been set to default one.  
You must Reset the card.
```

The card must be [restarted](#) in order for the new parameters to be taken into account.

7 Industrial Network Management Card (INMC option)

7.1 Presentation

7.1.1 Overview

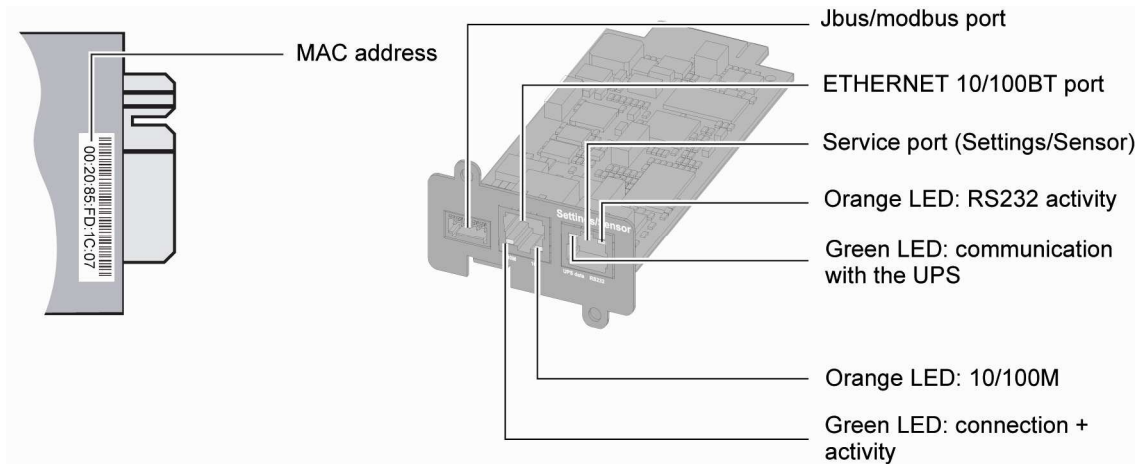

7.1.2 Functions

The Industrial Network Management Card (INMC) provides the same functions than the NMC card described in the previous section of this document.

The adding function consists to provide UPS (Uninterruptible Power Supply) data (states and measures) to be sent a computer system.

The JBUS hexadecimal (MODBUS RTU) communication protocol is used in slave mode. The system provides a communication channel with an RS485 or RS232 interface.

Note:

- 2 wires or 4 wires RS485 link are available.

Warning:

- RS232 and RS485 communication ports cannot be used together.
- JBUS/MODBUS communication is operational 2 minutes after the startup of the card.

7.1.3 Technical characteristics

| Functions | Parameters | Default values | Possible values |
|---------------------------|--|--|--|
| JBUS/MODBUS communication | <ul style="list-style-type: none"> - Baud rate - Parity - Slave number | <ul style="list-style-type: none"> - 9600 bauds - without parity - Slave nr 1 | <ul style="list-style-type: none"> - 1200, 2400, 4800, 9600 - Without parity, even parity - 1 to FF (hexadecimal) |
| RS232 link | <ul style="list-style-type: none"> - Link connection in transmit data (Tx) or receive data (Rx) | <ul style="list-style-type: none"> - Rx on pin 1 - Tx on pin 3 | <ul style="list-style-type: none"> - Rx on pin 1 - Tx on pin 3 |
| RS485 link | <ul style="list-style-type: none"> - Termination | <ul style="list-style-type: none"> - No termination | <ul style="list-style-type: none"> - With or without (2 or 4 wires) |

7.2 Installation

7.2.1 RS232 link configuration and connection

Set the SA2 switches like below:

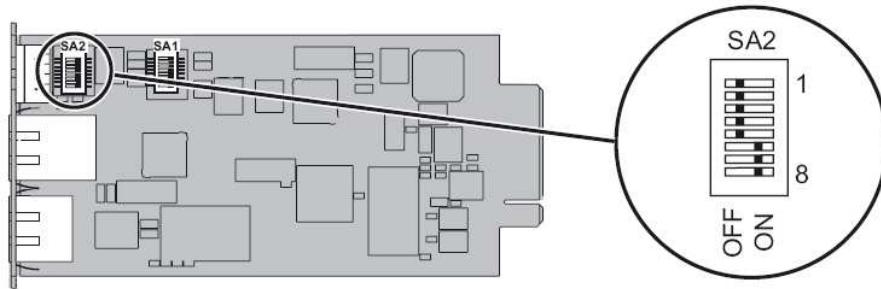

The next figure shows the details of the connection in RS232 mode:

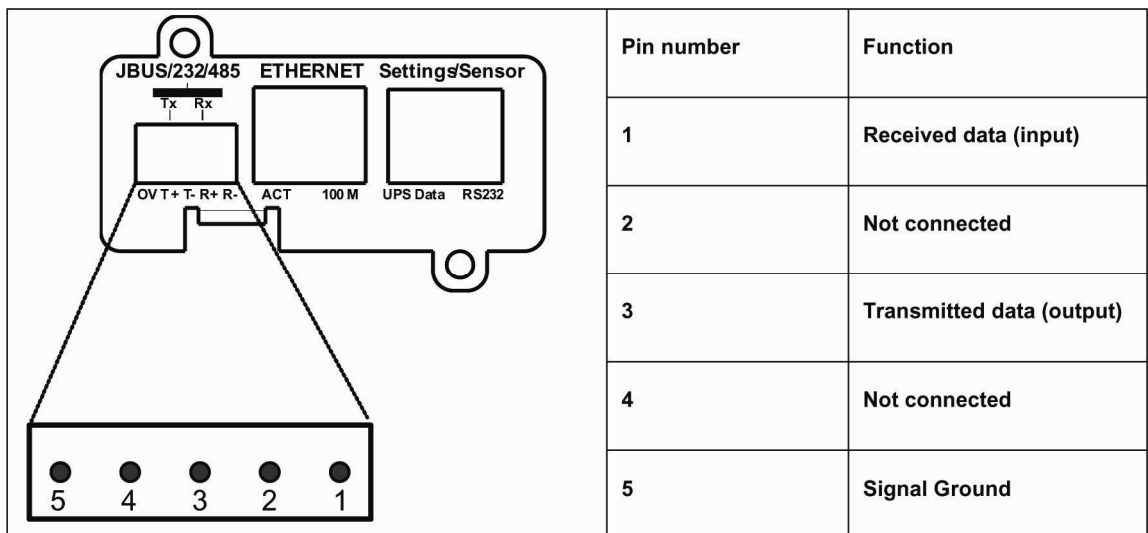

7.2.2 RS485 link configuration and connection

7.2.2.1 RS485 connection

The EIA RS485 link, 2 wires or 4 wires, must be polarized at a unique point of the link and must be adapted at both ends for a good working.

Normally, the master of the network sets the polarity of the line. The INMC card is a slave equipment and don't have polarisation resistor.

The two ends of the line must be terminated. Allow for 1 or 2 terminators to avoid mismatching the line when any equipment at the end of the line is disconnected.

The next figure gives the detail of the RS485 connector and the internals drivers:

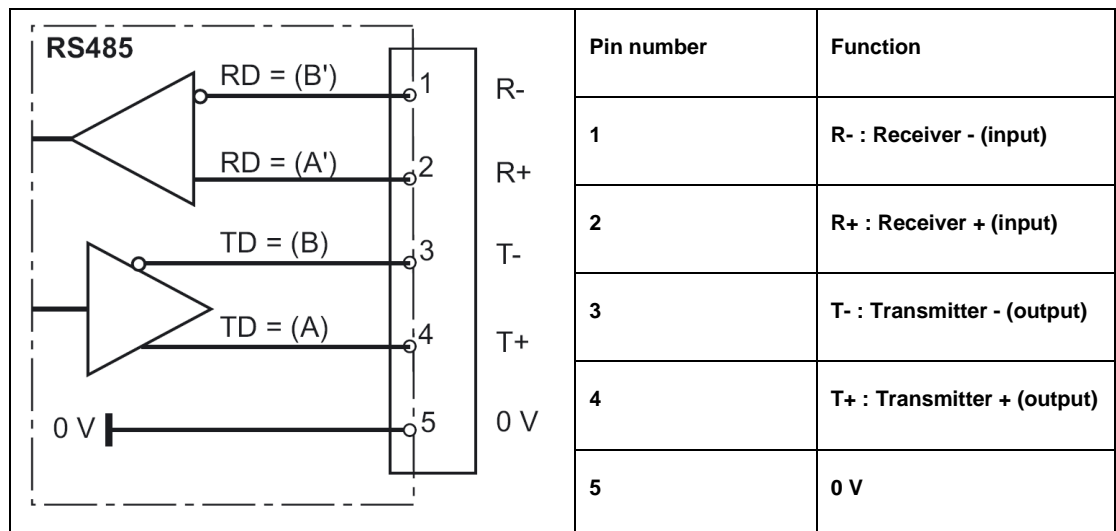

Important notes:

Use twisted pair cable (cable specification 0.3mm² and capacitance 42pF/m)

The transmission range will increase if a cable with lower capacitance and larger diameter is used.

Use shielded cable in heavy industrial environments.

The settings of the RS485 link are made through the SA1 switches:

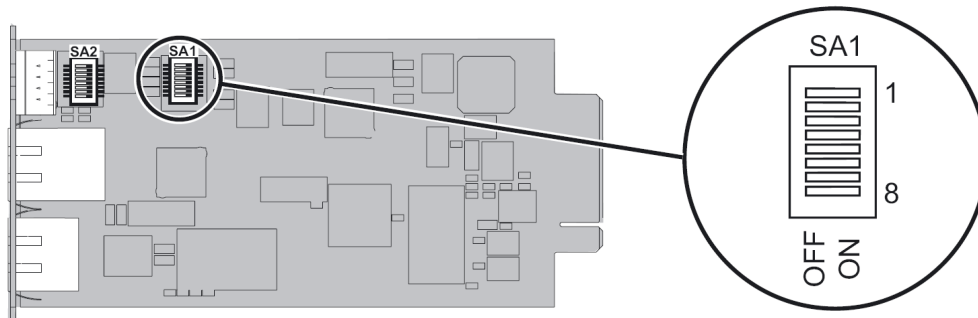

SA1 description:

1: reserved

2: reserved

3: link termination between T- to R- (2 wires configuration) if set to ON

4: connection T- to R- (2 wires configuration) if set to ON

5: connection T+ to R+ (2 wires configuration) if set to ON

6: reserved

7: reserved

8: link termination between R+ and R- if set to ON

7.2.2.2 RS485 link configuration for 2 wires connexion

Set the SA2 switches like below to set the RS485 mode:

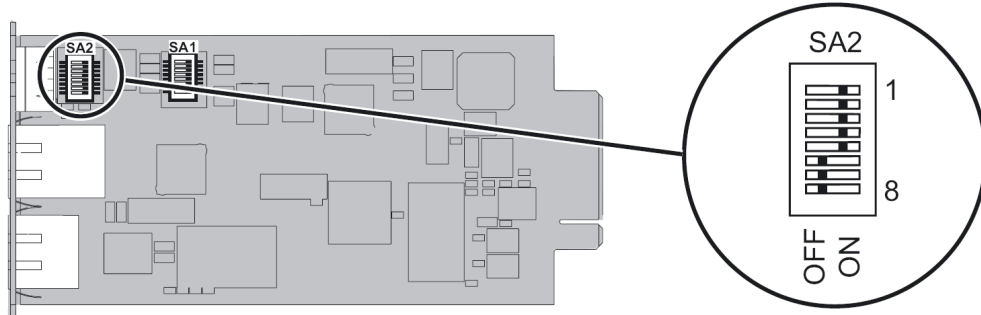

Set the SA1 switches to select the two wires configuration with no termination:

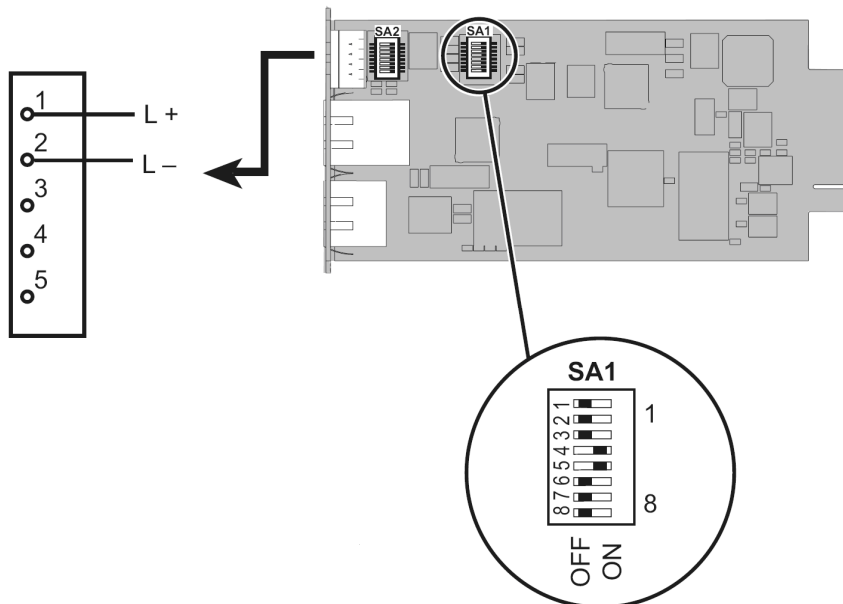

Set the SA1 switches to select the two wires configuration with termination:

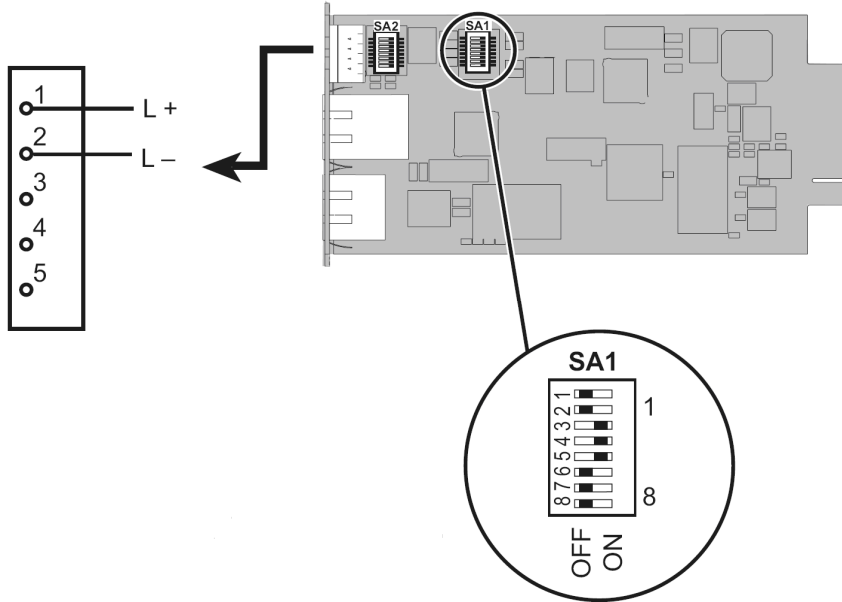

The next figure gives a typical bus structure in the two wires configuration:

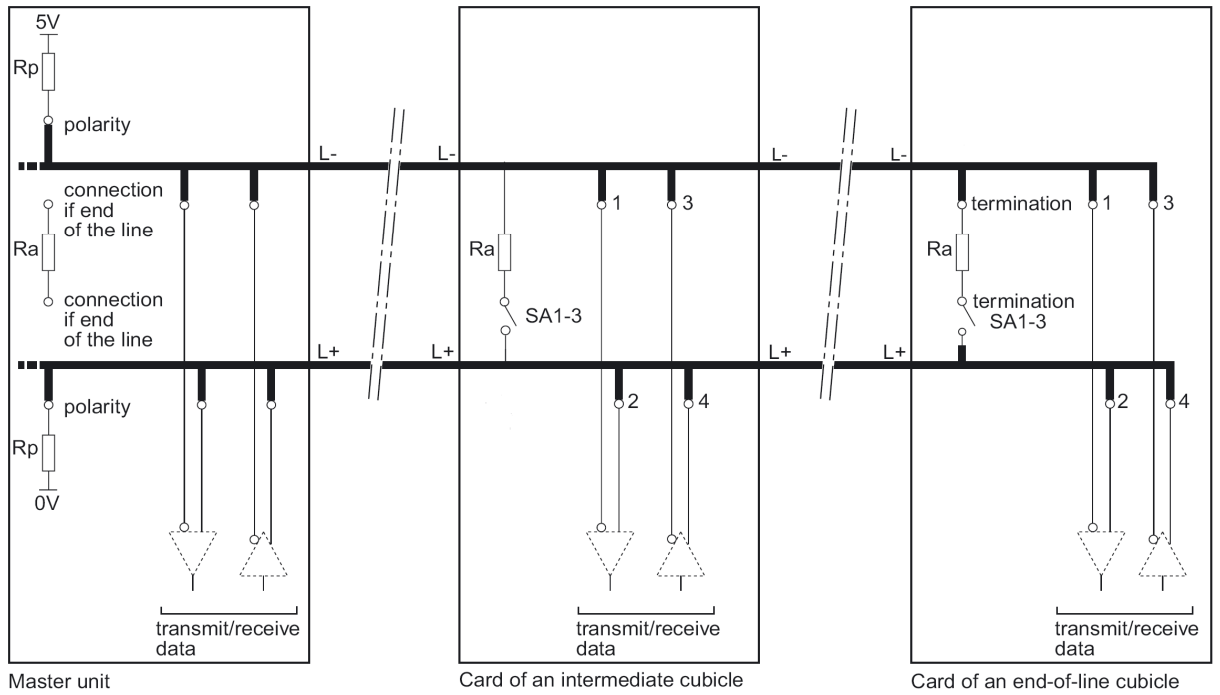

7.2.2.3 RS485 link configuration for 4 wires connexion

Set the SA2 switches like below:

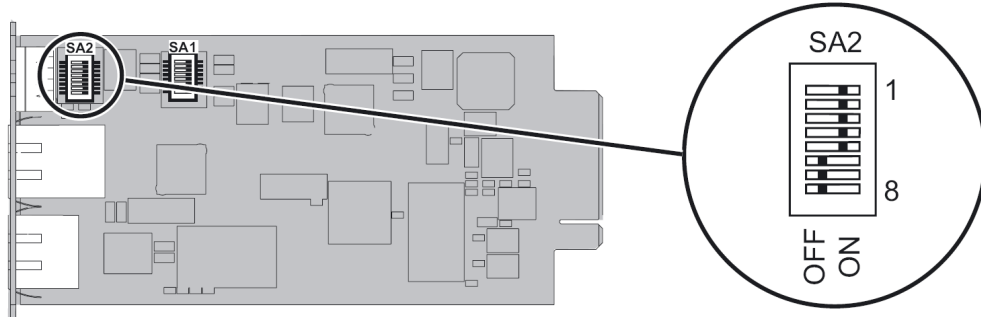

Set the SA1 switches to select the four wires configuration with no termination:

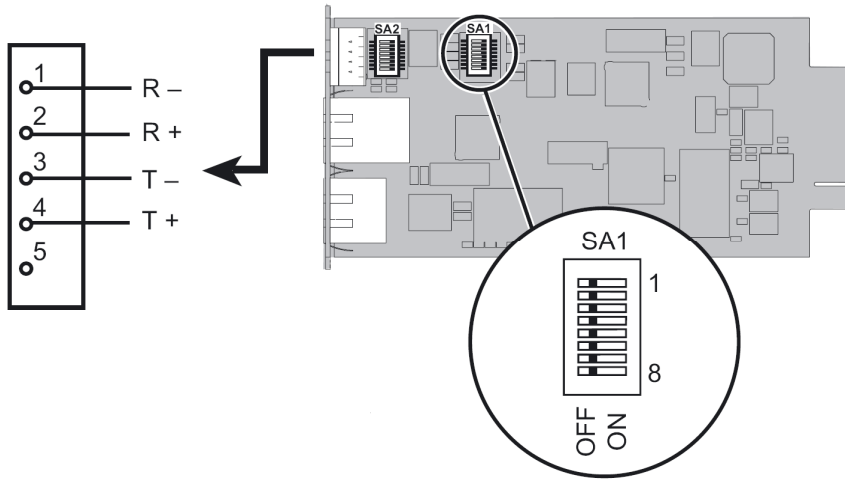

Set the SA1 switches to select the four wires configuration with termination:

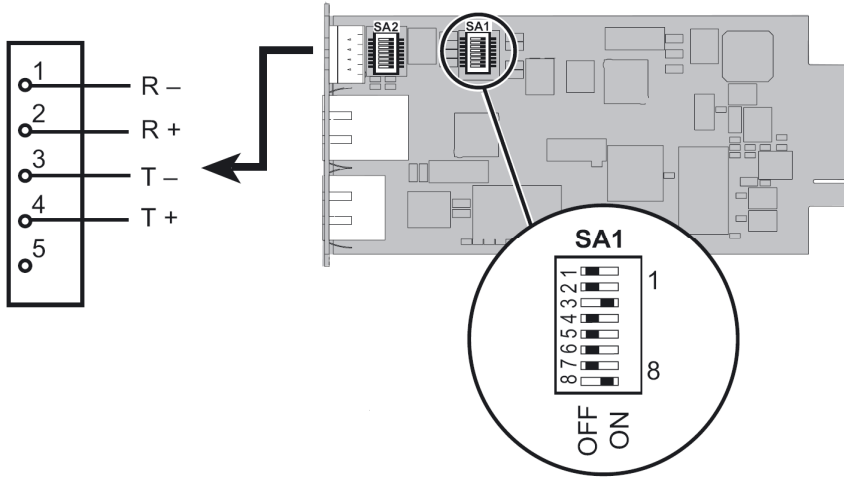

The next figure gives a typical bus structure in the four wires configuration:

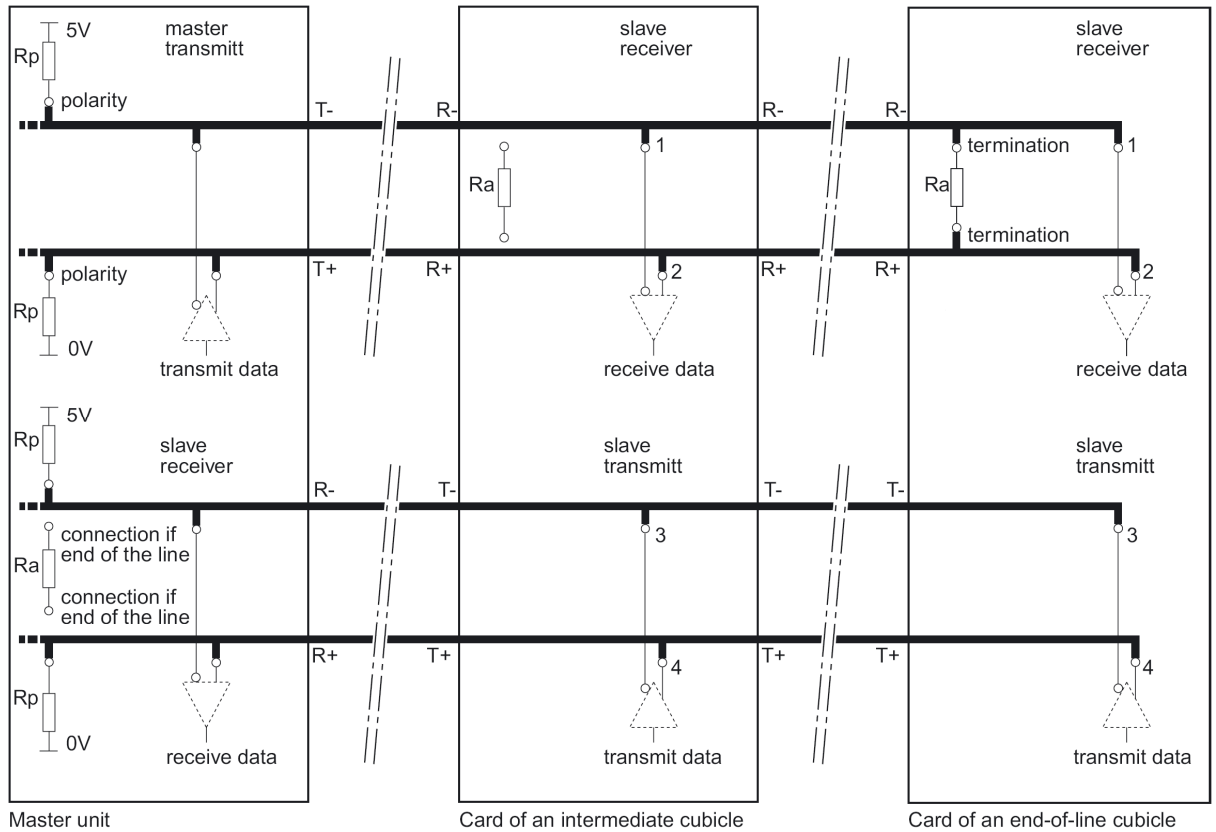

7.2.3 Configuration of the JBUS/MODBUS communication parameters

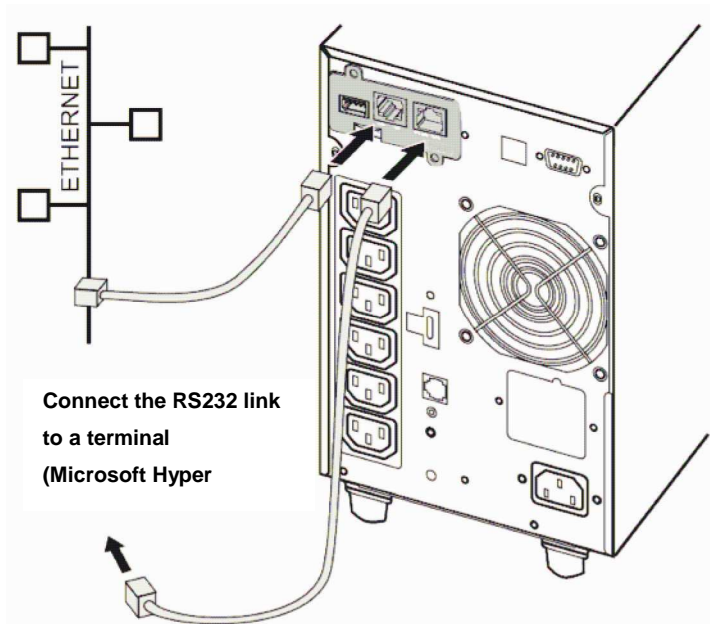

- Use the cord supplied with the card.

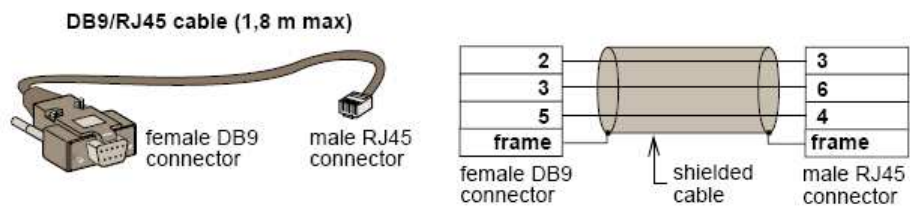

- Connect the card to a computer equipped with a Hyper terminal type emulator. The serial link must be set at 9600 baud, 8 bits, no parity, 1 stop bit, and without flow control.
- Check that UPS power is on.
- Enter the admin password (not modifiable).

- The next menu appears:

```
-----  
EATON  
NETWORK MANAGEMENT CARD  
-----  
1 : Reset  
2 : Network configuration  
3 : Set Login Password to Default  
4 : Return to Default Configuration  
5 : Jbus configuration  
6 : Sensor configuration  
0 : Exit  
-----
```

- Type 5 and return to display the JBUS configuration menu.
-
- The next menu appears:

```
-----  
Jbus settings  
-----  
1 : Display Jbus settings  
2 : Modify Jbus settings  
3 : Display Jbus diagnostics  
4 : Reset Jbus diagnostics  
5 : Return to Jbus Default Configuration  
6 : Display Jbus frames  
0 : Exit  
-----
```

7.2.3.1 Choice 1: Display Jbus settings

Enables reading of the card's Jbus settings

```
Jbus configuration :  
Slave number : 7  
Speed : 9600 bds  
Data : 8 bits  
stop bit : 1  
Parity : None
```

7.2.3.2 Choice 2: Modify Jbus settings

Enables the modification of Jbus settings.

Setting Jbus configuration :

- Set Slave number : 0x7
- Set the Baud Rate [1: 38400, 2: 19200, 3: 9600, 4: 4800, 5: 2400, 6: 1200] :3
- Set data format [1: 8 bits, 2: 7 bits] :1
- Set stop bit [1: 1 bits, 2: 2 bits] :1
- Set Parity [1: None, 2: Even, 3: Odd] :1

Wait during the new setting is saved ...
TLS/ Slave JBUS initialized
The Jbus configuration is now updated.

7.2.3.3 Choice 3: Display Jbus diagnostics

Enables reading of the Jbus diagnostics.

Jbus diagnostics :

- Cpt1 - Bus Message Count:0
- Cpt2 - CRC Error Count :0
- Cpt3 - Slave Exception Error Count:0
- Cpt4 - Slave Message Count:0
- Cpt5 - Slave No Response Count:0
- Cpt6 - Slave NAK Count:0
- Cpt7 - Slave Busy Count:0
- Cpt8 - Bus Character Overrun Count:0
- Cpt9 - Slave Correct Response Count:0

7.2.3.4 Choice 4: Reset Jbus diagnostics

Reset the Jbus diagnostic counters.

7.2.3.5 Choice 5: Return to Jbus Default Configuration

Returns to the Jbus default configuration (0x01, 9600, 8, 1, none)

Wait during Jbus configuration returns to default ...
Jbus Configuration has been set to default one.

7.2.3.6 Choice 6: Display Jbus frames

Enables the display of the Jbus frames:

```
Recv : 01 01 00 00 00 64 3d e1
```

```
Send : 01 81 02 c1 91
```

```
Recv : 01 03 00 62 00 64 e5 ff
```

```
Send : 01 03 c8 00 00 00 00 00 00 00 00 00 00 00 ...
```

```
Recv : 01 01 00 00 00 64 3d e1
```

```
Send : 01 81 02 c1 91
```

```
Recv : 01 03 00 62 00 64 e5 ff
```

```
Send : 01 03 c8 00 00 00 00 00 00 00 00 00 00 00 ...
```

7.3 Additional Web pages

The INMC card Jbus parameters could be set through the next page:

Network Management Card & ModBus/JBus

| UPS | ModBus/JBus Settings | Help |
|--|--|----------------------|
| <ul style="list-style-type: none">UPS PropertiesUPS ControlWeekly ScheduleShutdown Parameters | Pulsar M 2200 | Computer Room |
| Logs and Notification | Slave Number (Hex) : <input type="text" value="1"/> | |
| <ul style="list-style-type: none">MeasurementsEvent LogSystem LogEmail Notification | Serial speed : <input type="text" value="9600"/> | |
| Settings | Data format : <input type="text" value="8"/> | |
| <ul style="list-style-type: none">NetworkSystemNotified ApplicationsAccess ControlTimeFirmware Upload | Stop bit : <input type="text" value="1"/> | |
| ModBus/JBus serial | Parity : <input type="text" value="None"/> | |
| <ul style="list-style-type: none">Settings | Save modified settings : <input type="button" value="Save"/> | |
| | <input type="button" value="Factory Reset"/> | |

7.4 JBUS table

7.4.1 Data for Pulsar 700 / 1000 / 1500

7.4.1.1 Status table

| Status description | Status to 0 | Status to 1 | Word (hex) | Bit |
|------------------------------------|---------------|-------------|------------|-------|
| Load protected | no | yes | 40 | 0 |
| UPS coupled | no | yes | 40 | 1 |
| Unit general alarm | no | yes | 40 | 2 |
| UPS in backup | no | yes | 40 | 4 |
| Battery low warning | no | yes | 40 | 5 |
| Low battery | no | yes | 40 | 6 |
| Operation on static switch | no | yes | 40 | 7 |
| Communication fault | absent | present | 40 | 9 |
| UPS overload | no | yes | 40 | A |
| Emergency stop | absent | present | 40 | B |
| Battery to be checked | no | yes | 40 | D |
| Device ventilation fault | no | yes | 40 | E |
| Battery present | absent | present | 42 | 0 |
| Mains 1 voltage out of tolerance | no | yes | 44 | 8 |
| Mains 1 frequency out of tolerance | no | yes | 44 | B |
| Bypass status | no | yes | 46 | 7 |
| Charger general fault | no | yes | 49 | 0 |
| Battery charge | not in charge | in charge | 49 | 1 & 3 |
| Converter fault | no | yes | 4A | 1 |
| Inverter fault | no | yes | 4C | 1 |

7.4.1.2 Measurements table

| Description of the physical quantity | Word (hex) | Unit |
|--------------------------------------|------------|------|
| I output | 109 | A |
| U output | 124 | V |
| U battery | 12D | V |
| Output active power | 136 | W |
| Output apparent power | 137 | VA |
| % output load level | 139 | % |
| Power factor (Cos PHI) | 13D | - |
| Mains 1 frequency | 13E | Hz |
| Output frequency | 141 | Hz |
| Battery backup time | 149 | Min |
| Battery charging level | 14B | % |
| U mains 1 | 150 | V |
| Nominal voltage of battery element | 213 | V |

7.4.2 Data for Pulsar M 2200 / 3000

7.4.2.1 Status table

| Status description | Status to 0 | Status to 1 | Word (hex) | Bit |
|------------------------------------|-------------|-------------|------------|-------|
| Load protected | no | yes | 40 | 0 |
| UPS coupled | no | yes | 40 | 1 |
| Unit general alarm | no | yes | 40 | 2 |
| UPS in backup | no | yes | 40 | 4 |
| Battery low warning | no | yes | 40 | 5 |
| Low battery | no | yes | 40 | 6 |
| Operation on static switch | no | yes | 40 | 7 |
| Communication fault | absent | present | 40 | 9 |
| UPS overload | no | yes | 40 | A |
| Emergency stop | absent | present | 40 | B |
| Battery to be checked | no | yes | 40 | D |
| Device ventilation fault | no | yes | 40 | E |
| Manual bypass switch (Q3BP) | open | closed | 41 | 6 |
| Battery present | absent | present | 42 | 0 |
| Mains 1 voltage out of tolerance | no | yes | 44 | 8 |
| Mains 1 frequency out of tolerance | no | yes | 44 | B |
| Redundancy lost | no | yes | 45 | 7 |
| Maintenance position | no | yes | 46 | 1 |
| Mains 2 overload | no | yes | 46 | 5 |
| Output on bypass | no | yes | 46 | 7 |
| Mains 2 frequency out of tolerance | no | yes | 46 | 9 |
| Mains 2 voltage out of tolerance | no | yes | 46 | A |
| Phase M2 out of tolerance | no | yes | 46 | B |
| Charger general fault | no | yes | 49 | 0 |
| Battery charge | no | yes | 49 | 1 & 3 |
| Converter fault | no | yes | 4A | 1 |
| Inverter major fault | no | yes | 4C | 1 |

7.4.2.2 Measurements table

| Description of the physical quantity | Word (hex) | Unit |
|--------------------------------------|------------|------|
| I mains 2 | 106 | A |
| I output | 109 | A |
| U mains 2 | 11E | V |
| U output | 124 | V |
| U battery | 12D | V |
| Output active power | 136 | W |
| Output apparent power | 137 | VA |
| % output load level | 139 | % |
| Power factor x 100 | 13D | - |
| Mains 1 frequency | 13E | dHz |
| Output frequency | 141 | dHz |
| Battery backup time | 149 | Min |
| Battery charging level | 14B | % |
| U mains 1 | 150 | V |
| Nominal voltage of battery element | 213 | V |

7.4.3 Data for Pulsar MX 4000 / 5000 / 10000 and EX 5 / 7 / 11 RT

7.4.3.1 Status table

| Status description | Status to 0 | Status to 1 | Word (hex) | Bit |
|------------------------------------|-------------|-------------|------------|-------|
| Load protected | no | yes | 40 | 0 |
| UPS coupled | no | yes | 40 | 1 |
| Unit general alarm | no | yes | 40 | 2 |
| UPS in backup | no | yes | 40 | 4 |
| Battery low warning | no | yes | 40 | 5 |
| Low battery | no | yes | 40 | 6 |
| Operation on static switch | no | yes | 40 | 7 |
| Communication fault | absent | present | 40 | 9 |
| UPS overload | no | yes | 40 | A |
| Emergency stop | absent | present | 40 | B |
| Battery to be checked | no | yes | 40 | D |
| Device ventilation fault | no | yes | 40 | E |
| Manual bypass switch (Q3BP) | open | closed | 41 | 6 |
| UPS in "eco" mode | no | yes | 41 | 7 |
| Battery present | absent | present | 42 | 0 |
| Mains 1 voltage out of tolerance | no | yes | 44 | 8 |
| Mains 1 fuse fault | no | yes | 44 | 9 |
| Mains 1 frequency out of tolerance | no | yes | 44 | B |
| Redundancy lost | no | yes | 45 | 7 |
| Maintenance position | no | yes | 46 | 1 |
| Mains 2 overload | no | yes | 46 | 5 |
| Mains 2 thermal overload | no | yes | 46 | 6 |
| Output on bypass | no | yes | 46 | 7 |
| Mains 2 frequency out of tolerance | no | yes | 46 | 9 |
| Mains 2 voltage out of tolerance | no | yes | 46 | A |
| Phase M2 out of tolerance | no | yes | 46 | B |
| Mains 2 internal fault | absent | present | 47 | 2 |
| Charger general fault | no | yes | 49 | 0 |
| Battery charge | no | yes | 49 | 1 & 3 |
| Converter fault | no | yes | 4A | 1 |
| Inverter major fault | no | yes | 4C | 1 |
| Inverter overload | no | yes | 4C | 2 |
| Inverter thermal overload | no | yes | 4C | 3 |
| Inverter limitation | no | yes | 4C | 4 |
| UPS fuse fault | absent | present | 4C | 5 |

7.4.3.2 Measurements table

| Description of the physical quantity | Word (hex) | Unit |
|--------------------------------------|------------|------|
| I mains 1 | 100 | A |
| I mains 2 | 106 | A |
| I output | 109 | A |
| I battery | 10E | A |
| U mains 2 | 11E | V |
| U output | 124 | V |
| U battery | 12D | V |
| Output active power | 136 | W |
| Output apparent power | 137 | VA |
| % output load level | 139 | % |
| Power factor (Cos PHI) | 13D | - |
| Mains 1 frequency | 13E | dHz |
| Mains 2 frequency | 140 | dHz |
| Output frequency | 141 | dHz |
| Battery backup time | 149 | Min |
| Battery charging level | 14B | % |
| U mains 1 | 150 | V |
| Nominal voltage of battery element | 213 | V |

7.4.4 Data for Pulsar MX frame 15 / 20

7.4.4.1 Status table

| Status description | Status to 0 | Status to 1 | Word (hex) | Bit |
|------------------------------------|-------------|-------------|------------|-------|
| Load protected | no | yes | 40 | 0 |
| UPS coupled | no | yes | 40 | 1 |
| Unit general alarm | no | yes | 40 | 2 |
| UPS in backup | no | yes | 40 | 4 |
| Battery low warning | no | yes | 40 | 5 |
| Low battery | no | yes | 40 | 6 |
| Operation on static switch | no | yes | 40 | 7 |
| Communication fault | absent | present | 40 | 9 |
| UPS overload | no | yes | 40 | A |
| Emergency stop | absent | present | 40 | B |
| Battery to be checked | no | yes | 40 | D |
| Device ventilation fault | no | yes | 40 | E |
| Manual bypass switch (Q3BP) | open | closed | 41 | 6 |
| Battery present | absent | present | 42 | 0 |
| Mains 1 voltage out of tolerance | no | yes | 44 | 8 |
| Mains 1 fuse fault | no | yes | 44 | 9 |
| Mains 1 frequency out of tolerance | no | yes | 44 | B |
| Redundancy lost | no | yes | 45 | 7 |
| Maintenance position | no | yes | 46 | 1 |
| Mains 2 overload | no | yes | 46 | 5 |
| Mains 2 thermal overload | no | yes | 46 | 6 |
| Output on bypass | no | yes | 46 | 7 |
| Mains 2 frequency out of tolerance | no | yes | 46 | 9 |
| Mains 2 voltage out of tolerance | no | yes | 46 | A |
| Phase M2 out of tolerance | no | yes | 46 | B |
| Mains 2 internal fault | absent | present | 47 | 2 |
| Charger general fault | no | yes | 49 | 0 |
| Battery charge | no | yes | 49 | 1 & 3 |
| Inverter major fault | no | yes | 4C | 1 |
| Inverter overload | no | yes | 4C | 2 |
| Inverter thermal overload | no | yes | 4C | 3 |
| Inverter limitation | no | yes | 4C | 4 |
| UPS fuse fault | absent | present | 4C | 5 |

7.4.4.2 Modular fault table

| Description du Status | | Status to 0 | Status to 1 | Word (hex) | Bit |
|-----------------------|------------------------------|-------------|-------------|------------|-----|
| Module 1 | General alarm | Absent | Present | 61 | 0 |
| | Fan failure | Absent | Present | 61 | 1 |
| | Internal communication fault | Absent | Present | 61 | 2 |
| | Inverter thermal overload | Absent | Present | 61 | 3 |
| | Inverter fault | Absent | Present | 61 | 4 |
| | Inverter fuse blown | Absent | Present | 61 | 5 |
| | Load short circuit | Absent | Present | 61 | 6 |
| Module 2 | General alarm | Absent | Present | 62 | 0 |
| | Fan failure | Absent | Present | 62 | 1 |
| | Internal communication fault | Absent | Present | 62 | 2 |
| | Inverter thermal overload | Absent | Present | 62 | 3 |
| | Inverter fault | Absent | Present | 62 | 4 |
| | Inverter fuse blown | Absent | Present | 62 | 5 |
| | Load short circuit | Absent | Present | 62 | 6 |
| Module 3 | General alarm | Absent | Present | 63 | 0 |
| | Fan failure | Absent | Present | 63 | 1 |
| | Internal communication fault | Absent | Present | 63 | 2 |
| | Inverter thermal overload | Absent | Present | 63 | 3 |
| | Inverter fault | Absent | Present | 63 | 4 |
| | Inverter fuse blown | Absent | Present | 63 | 5 |
| | Load short circuit | Absent | Present | 63 | 6 |
| Module 4 | General alarm | Absent | Present | 64 | 0 |
| | Fan failure | Absent | Present | 64 | 1 |
| | Internal communication fault | Absent | Present | 64 | 2 |
| | Inverter thermal overload | Absent | Present | 64 | 3 |
| | Inverter fault | Absent | Present | 64 | 4 |
| | Inverter fuse blown | Absent | Present | 64 | 5 |
| | Load short circuit | Absent | Present | 64 | 6 |

| Description du Status | | Status to 0 | Status to 1 | Word (hex) | Bit |
|-----------------------|------------------------------|-------------|-------------|------------|-----|
| Module 5 | General alarm | Absent | Present | 65 | 0 |
| | Fan failure | Absent | Present | 65 | 1 |
| | Internal communication fault | Absent | Present | 65 | 2 |
| | Inverter thermal overload | Absent | Present | 65 | 3 |
| | Inverter fault | Absent | Present | 65 | 4 |
| | Inverter fuse blown | Absent | Present | 65 | 5 |
| | Load short circuit | Absent | Present | 65 | 6 |
| Module 6 | General alarm | Absent | Present | 66 | 0 |
| | Fan failure | Absent | Present | 66 | 1 |
| | Internal communication fault | Absent | Present | 66 | 2 |
| | Inverter thermal overload | Absent | Present | 66 | 3 |
| | Inverter fault | Absent | Present | 66 | 4 |
| | Inverter fuse blown | Absent | Present | 66 | 5 |
| | Load short circuit | Absent | Present | 66 | 6 |
| Module 7 | General alarm | Absent | Present | 67 | 0 |
| | Fan failure | Absent | Present | 67 | 1 |
| | Internal communication fault | Absent | Present | 67 | 2 |
| | Inverter thermal overload | Absent | Present | 67 | 3 |
| | Inverter fault | Absent | Present | 67 | 4 |
| | Inverter fuse blown | Absent | Present | 67 | 5 |
| | Load short circuit | Absent | Present | 67 | 6 |
| Module 8 | General alarm | Absent | Present | 68 | 0 |
| | Fan failure | Absent | Present | 68 | 1 |
| | Internal communication fault | Absent | Present | 68 | 2 |
| | Inverter thermal overload | Absent | Present | 68 | 3 |
| | Inverter fault | Absent | Present | 68 | 4 |
| | Inverter fuse blown | Absent | Present | 68 | 5 |
| | Load short circuit | Absent | Present | 68 | 6 |

7.4.4.3 Measurements table

| Description of the physical quantity | Word (hex) | Unit |
|--------------------------------------|------------|------|
| I1 (I phase 1) mains 1 | 100 | A |
| I2 (I phase 2) mains 1 | 101 | A |
| I3 (I phase 3) mains 1 | 102 | A |
| I1 (I phase 1) mains 2 | 106 | A |
| I2 (I phase 2) mains 2 | 107 | A |
| I3 (I phase 3) mains 2 | 108 | A |
| I1 (I phase 1) output | 109 | A |
| I2 (I phase 2) output | 10A | A |
| I3 (I phase 3) output | 10B | A |
| I battery | 10E | A |
| U12 mains 1 | 115 | V |
| U23 mains 1 | 116 | V |
| U31 mains 1 | 117 | V |
| U mains 2 (phase 1) | 11E | V |
| U mains 2 (phase 2) | 11F | V |
| U mains 2 (phase 3) | 120 | V |
| U12 mains 2 | 121 | V |
| U23 mains 2 | 122 | V |
| U31 mains 2 | 123 | V |
| U1N output | 124 | V |
| U2N output | 125 | V |
| U3N output | 126 | V |
| U12 output | 127 | V |
| U23 output | 128 | V |
| U31 output | 129 | V |
| U battery | 12D | V |
| Output active power (phase 1) | 130 | W |
| Output active power (phase 2) | 131 | W |
| Output active power (phase 3) | 132 | W |
| Output apparent power (phase 1) | 133 | VA |
| Output apparent power (phase 2) | 134 | VA |
| Output apparent power (phase 3) | 135 | VA |
| Output total active power | 136 | W |
| Output total apparent power | 137 | VA |
| % output load level | 139 | % |
| Peak factor phase 1 x 100 | 13A | - |
| Peak factor phase 2 x 100 | 13B | - |
| Peak factor phase 3 x 100 | 13C | - |
| Power factor x 100 | 13D | - |
| Mains 1 frequency | 13E | dHz |
| Mains 2 frequency | 140 | dHz |
| Output frequency | 141 | dHz |
| Battery backup time | 149 | Min |
| Battery charging level | 14B | % |

| Description of the physical quantity | Word (hex) | Unit |
|--------------------------------------|------------|------|
| U mains 1 (phase 1) | 150 | V |
| U mains 1 (phase 2) | 151 | V |
| U mains 1 (phase 3) | 152 | V |
| Nominal voltage of battery element | 213 | V |

7.4.5 Sensor data

7.4.5.1 Status table

| Status description | Status to 0 | Status to 1 | Word (hex) | Bit |
|------------------------------|-------------|-------------|------------|-----|
| Input 1 alarm | no | yes | 45 | 5 |
| Input 2 alarm | no | yes | 45 | 6 |
| Alarm : humidity too low | no | yes | 45 | 4 |
| Alarm : humidity too high | no | yes | 45 | 3 |
| Alarm : temperature too low | no | yes | 45 | 2 |
| Alarm : temperature too high | no | yes | 45 | 1 |
| Communication fault | no | yes | 45 | 0 |
| Input 1 | open | close | 48 | 0 |
| Input 2 | open | close | 48 | 1 |

7.4.5.2 Measurements table

| Description of the physical quantity | Word (hex) | Unit |
|--|------------|---------|
| Temperature measure | 180 | °C / °F |
| Maximum temperature | 181 | °C / °F |
| Maximum temperature date (MSB) in Unix timestamp | 182 | |
| Maximum temperature date (LSB) in Unix timestamp | 183 | |
| Minimum temperature (°C) | 184 | °C / °F |
| Minimum temperature date (MSB) in Unix timestamp | 185 | |
| Minimum temperature date (LSB) in Unix timestamp | 186 | |
| Humidity measure (%) | 187 | % |
| Maximum humidity (%) | 188 | % |
| Maximum humidity date (MSB) in Unix timestamp | 189 | |
| Maximum humidity date (LSB) in Unix timestamp | 190 | |
| Minimum humidity (%) | 18B | % |
| Minimum humidity date (MSB) in Unix timestamp | 192 | |
| Minimum humidity date (LSB) in Unix timestamp | 193 | |
| Input 1 changing date (MSB) in Unix timestamp | 194 | |
| Input 1 changing date (LSB) in Unix timestamp | 195 | |
| Input 2 changing date (MSB) in Unix timestamp | 196 | |
| Input 2 changing date (LSB) in Unix timestamp | 197 | |

7.4.5.3 Read of the personalization table

| Description | Word (hex) | Unit |
|--|------------|------|
| High threshold temperature (°C) | 32C | 0 |
| Low threshold temperature (°C) | 32D | 0 |
| Temperature hysteresis (°C) | 32E | 0 |
| Offset temperature | 32F | 0 |
| High threshold humidity (%) | 330 | 0 |
| Low threshold humidity (%) | 331 | 0 |
| Humidity hysteresis (%) | 332 | 0 |
| Humidity offset | 333 | 0 |
| Inputs call mask – input 1 close notification | 334 | 0 |
| Inputs call mask – input 2 close notification | 334 | 2 |
| Inputs call mask – low humidity notification | 334 | 7 |
| Inputs call mask – high humidity notification | 334 | 6 |
| Inputs call mask – input 1 open notification | 334 | 1 |
| Inputs call mask – input 2 open notification | 334 | 3 |
| Inputs call mask – low temperature notification | 334 | 5 |
| Inputs call mask – high temperature notification | 334 | 4 |
| Input 1 identification | 336 | 0 |
| Input 2 identification | 33A | 0 |

7.4.6 Other data

| Information description | Word (hex) | Example |
|-------------------------|------------|---------------|
| Manufacturer name | 1A0 | « EATON » |
| Product name | 1A8 | « Pulsar » |
| UPS model | 1B0 | « 700 » |
| Serial number | 1B8 | « AN2E49008 » |

8 Appendices

8.1 Tables of alarms and events

8.1.1 Table of alarms

List of time dated alarms

Alarm on

Battery fuse blown

No Battery

Battery temperature fault

Battery charger fault

Battery fault

MAX charger voltage fault

MIN charger voltage fault

Charger temperature fault

Rectifier fault

Chopper fault

Normal AC frequency out of tolerance

Normal AC fuses blown

Normal AC module fault

Normal AC voltage out of tolerance

Normal AC NOK

Site wiring fault

Bypass AC frequency out of tolerance

Bypass AC phase out of tolerance

Bypass AC voltage out of tolerance

Automatic Bypass fault

Automatic Bypass overload

Automatic Bypass overtemperature

Automatic Bypass thermal overload

Automatic Bypass switch (Q4S) open

Normal AC switch (Q1) open

Battery switch (QF1) open

Manual Bypass switch (Q3BP) closed

UPS on manual bypass

Output switch (Q5N) open

Single wave load fault

Negative DC bus too high

Positive DC bus too high

Negative DC bus too low

Positive DC bus too low

Inverter limitation

Inverter fuses blown

Inverter fault

Alarm off

Battery fuse OK

Battery present

Battery temperature OK

Battery charger OK

Battery OK

Charger voltage OK

Charger voltage OK

Charger temperature OK

Rectifier OK

Chopper OK

Normal AC frequency OK

Normal AC fuses OK

Normal AC module OK

Normal AC voltage OK

Normal AC OK

Site wiring OK

Bypass AC frequency OK

Bypass AC phase OK

Bypass AC voltage OK

Automatic Bypass OK

Automatic Bypass load OK

Automatic Bypass temperature OK

Automatic Bypass load OK

Automatic Bypass switch (Q4S) closed

Normal AC switch (Q1) closed

Battery switch (QF1) closed

Manual Bypass switch (Q3BP) open

Output switch (Q5N) closed

Load OK

Negative DC bus OK

Positive DC bus OK

Negative DC bus OK

Positive DC bus OK

Inverter end of limitation

Input fuses OK

Inverter OK

Inverter overload
Inverter over temperature
Inverter short circuit
Inverter thermal overload
Load not protected - On Automatic Bypass
Load short circuit
Load not powered
Protection Lost
Emergency button ON
Fan fault
Redundancy Lost
Low battery
UPS communication failed
UPS data base not available
UPS on battery
UPS internal fault
UPS overload
UPS overtemperature
Imminent UPS shutoff
<Sensor name>:
Temperature is above high threshold xx °C
<Sensor name>:
Humidity is above high threshold xx %
<Sensor name>:
Temperature is below low threshold xx °C
<Sensor name>:
Humidity is below low threshold xx %
<Sensor name>: <Input #1 label> <when closed label>
<Sensor name>: <Input #1 label> <when open label>
<Sensor name>: <Input #2 label> <when closed label>
<Sensor name>: <Input #2 label> <when open label>

Inverter load OK
Inverter temperature OK
Inverter OK
Inverter load OK
Load protected - Return from Bypass
Load OK
Load powered
Protection OK
Emergency button OFF
Fan OK
Redundancy OK
Battery OK
UPS communication restored
UPS data base OK
UPS on normal AC
UPS OK
UPS returns to normal load
UPS temperature OK
UPS OK
<Sensor name>:
La température est au dessus du seuil haut xx °C
<Sensor name>:
L'humidité est au dessus du seuil haut xx %
<Sensor name>:
La température est en dessous du seuil bas xx °C
<Sensor name>:
L'humidité est en dessous du seuil bas xx %
<Sensor name>: <Input #1 label> <when closed label>
<Sensor name>: <Input #1 label> <when open label>
<Sensor name>: <Input #2 label> <when closed label>
<Sensor name>: <Input #2 label> <when open label>

If the UPS is modular UPS, for each module:

| | |
|--|--------------------------------------|
| Battery fuse blown | Battery fuse OK |
| No Battery | Battery present |
| Battery temperature fault | Battery temperature OK |
| Battery charger fault | Battery charger OK |
| Low battery | Battery OK |
| Charger temperature fault | Charger temperature OK |
| MAX charger voltage fault | Charger voltage OK |
| MIN charger voltage fault | Charger voltage OK |
| Chopper fault | Chopper OK |
| Normal AC fuses blown | Normal AC fuses OK |
| Normal AC module fault | Normal AC module OK |
| Inverter fuses blown | Input fuses OK |
| Inverter fault | Inverter OK |
| Inverter short circuit | Inverter OK |
| Load short circuit | Load OK |
| Rectifier fuse blown | Rectifier OK |
| Rectifier fault | Rectifier OK |
| DC bus unbalanced | Load OK |
| Emergency button ON | Emergency button OFF |
| Load not powered | Load powered |
| UPS internal fault | UPS OK |
| Battery fault | Battery OK |
| Imminent UPS shutoff | UPS OK |
| Normal AC frequency out of tolerance | Normal AC frequency OK |
| Normal AC voltage out of tolerance | Normal AC voltage OK |
| Normal AC switch (Q1) open | Normal AC switch (Q1) closed |
| Site wiring fault | Site wiring OK |
| Automatic Bypass switch (Q4S) open | Automatic Bypass switch (Q4S) closed |
| Bypass AC frequency out of tolerance | Bypass AC frequency OK |
| Automatic Bypass fault | Automatic Bypass OK |
| Automatic Bypass overload | Automatic Bypass load OK |
| Automatic Bypass overtemperature | Automatic Bypass temperature OK |
| Automatic Bypass thermal overload | Automatic Bypass load OK |
| Bypass AC phase out of tolerance | Bypass AC phase OK |
| Bypass AC voltage out of tolerance | Bypass AC voltage OK |
| Load not protected - On Automatic Bypass | Load protected - Return from Bypass |
| Battery switch (QF1) open | Battery switch (QF1) closed |
| Manual Bypass switch (Q3BP) closed | Manual Bypass switch (Q3BP) open |
| UPS on manual bypass | |
| Inverter limitation | Inverter end of limitation |
| Inverter overload | Inverter load OK |
| Inverter overtemperature | Inverter temperature OK |
| Inverter thermal overload | Inverter load OK |
| Negative DC bus too high | Negative DC bus OK |
| Positive DC bus too high | Positive DC bus OK |
| Negative DC bus too low | Negative DC bus OK |

Positive DC bus too low
Output switch (Q5N) open
Normal AC NOK
UPS on battery
UPS overload
UPS overtemperature
Fan fault
UPS communication failed

Positive DC bus OK
Output switch (Q5N) closed
Normal AC OK
UPS on normal AC
UPS returns to normal load
UPS temperature OK
Fan OK
UPS communication restored

8.1.2 Table of UPS events

List of time dated informations

Alarm on

Battery fuse blown

Battery temperature fault

No Battery

Battery charger fault

Charger temperature fault

MAX charger voltage fault

MIN charger voltage fault

End of Warranty

End of battery life

End of life of the wearing parts

Outlet 1 open

Outlet 2 open

Chopper fault

Normal AC switch (Q1) open

Normal AC frequency out of tolerance

Normal AC fuses blown

Normal AC module fault

Normal AC voltage out of tolerance

Site wiring fault

Automatic Bypass switch (Q4S) open

Bypass AC frequency out of tolerance

Automatic Bypass fault

Automatic Bypass overload

Automatic Bypass overtemperature

Bypass AC phase out of tolerance

Automatic Bypass thermal overload

Load not protected - On Automatic Bypass

Bypass AC voltage out of tolerance

Battery switch (QF1) open

Manual Bypass switch (Q3BP) closed

UPS on manual bypass

Inverter limitation

Inverter fuses blown

Alarm off

Battery fuse OK

Battery temperature OK

Battery present

Battery charger OK

Charger temperature OK

Charger voltage OK

Charger voltage OK

LCM message OK

LCM message OK

LCM message OK

Outlet 1 closed

Outlet 2 closed

Chopper OK

Normal AC switch (Q1) closed

Normal AC frequency OK

Normal AC fuses OK

Normal AC module OK

Normal AC voltage OK

Site wiring OK

Automatic Bypass switch (Q4S) closed

Bypass AC frequency OK

Automatic Bypass OK

Automatic Bypass load OK

Automatic Bypass temperature OK

Bypass AC phase OK

Automatic Bypass load OK

Load protected - Return from Bypass

Bypass AC voltage OK

Battery switch (QF1) closed

Manual Bypass switch (Q3BP) open

Inverter end of limitation

Input fuses OK

| | |
|---|--|
| Inverter fault | Inverter OK |
| Inverter overload | Inverter load OK |
| Inverter overtemperature | Inverter temperature OK |
| Inverter short circuit | Inverter OK |
| Inverter thermal overload | Inverter load OK |
| Output switch (Q5N) open | Output switch (Q5N) closed |
| Load short circuit | Load OK |
| Single wave load fault | Load OK |
| Negative DC bus too high | Negative DC bus OK |
| Positive DC bus too high | Positive DC bus OK |
| Rectifier fault | Rectifier OK |
| Negative DC bus too low | Negative DC bus OK |
| Positive DC bus too low | Positive DC bus OK |
| Protection Lost | Protection OK |
| Redundancy Lost | Redundancy OK |
| Normal AC NOK | Normal AC OK |
| Low battery | Battery OK |
| UPS communication failed | UPS communication restored |
| UPS data base not available | UPS data base OK |
| UPS on battery | UPS on normal AC |
| Emergency button ON | Emergency button OFF |
| Fan fault | Fan OK |
| Load not powered | Load powered |
| UPS internal fault | UPS OK |
| Battery fault | Battery OK |
| UPS overload | UPS returns to normal load |
| UPS overtemperature | UPS temperature OK |
| Imminent UPS shutoff | UPS OK |
| < Sensor Name> : Temperature is above high threshold <xx> (°C) or (°F) | <Sensor Name> : Temperature is in normal range |
| < Sensor Name> : Humidity is above high threshold <xx> (%) | <Sensor Name> : Temperature is in normal range |
| < Sensor Name> : Temperature is below low threshold <xx> °C or (°F) | <Sensor Name> : Temperature is in normal range |
| < Sensor Name> : Humidity is below high threshold <xx> (%) | <Sensor Name> : Temperature is in normal range |
| <Sensor name>: <Input #1 label> <when closed label> | |
| <Sensor name>: <Input #1 label> <when open label> | |
| <Sensor name>: <Input #2 label> <when closed label> | |
| <Sensor name>: <Input #2 label> <when open label>> | |

8.1.3 Table of system alarms

| |
|--|
| Network Management Card startup |
| Send test mail SUCCESS |
| Send test mail ERROR |
| Send mail to <recipient> ERROR |
| <Sensor name> Communication failure |
| <Sensor name> Communication restored |
| Firmware upgraded |
| Connected NSM list Full, last connection refused |
| sendTrap()-> Unable to resolve hostname <hostname> |
| SNMP Send Trap # <num> failure to <hostname> |
| Time changed by user with yyyy/mm/dd hh:mm:ss |
| Time synchronized by NSM or EPM with yyyy/mm/dd hh:mm:ss |

8.2 SNMP objects

8.2.1 EATON MIB

The NMC card implement reduce EATON MIB, with the objects bellow managed.

The entire MIB description is available on www.eaton.com area "[Downloads – Software Download](#)."

Le chemin d'accès à la MIB EATON est 1.3.6.1.4.1.705.1.

| MIB object | SNMP Format | Add.path |
|----------------------------|--------------|---------------|
| upsmgldentFamilyName | String | {1,1,0} |
| upsmgldentModelName | String | {1,2,0} |
| upsmgldentFirmwareVersion | String | {1,4,0} |
| upsmgldentSerialNumber | String | {1,7,0} |
| upsmgConfigLowBatteryTime | seconds | {4,7,0} |
| upsmgConfigLowBatteryLevel | % | {4,8,0} |
| upsmgConfigAutoRestart | 1(yes) 2(no) | {4,9,0} |
| upsmgConfigVARating | VA | {4,12,0} |
| upsmgBatteryRemainingTime | seconds | {5,1,0} |
| upsmgBatteryLevel | % | {5,2,0} |
| upsmgBatteryVoltage | deciVolts | {5,5,0} |
| upsmgBatteryCurrent | deciAmps | {5,6,0} |
| upsmgBatteryFaultBattery | 1(yes) 2(no) | {5,9,0} |
| upsmgBatteryReplacement | 1(yes) 2(no) | {5,11,0} |
| upsmgBatteryLowBattery | 1(yes) 2(no) | {5,14,0} |
| upsmgBatteryChargerFault | 1(yes) 2(no) | {5,15,0} |
| upsmgBatteryLowCondition | 1(yes) 2(no) | {5,16,0} |
| upsmgInputPhaseNum | | {6,1,0} |
| mginputVoltage_1 | DeciVolts | {6,2,1,2,1,0} |
| mginputVoltage_2 | DeciVolts | {6,2,1,2,2,0} |
| mginputVoltage_3 | DeciVolts | {6,2,1,2,3,0} |
| mginputFrequency_1 | DeciHz | {6,2,1,3,1,0} |
| mginputFrequency_2 | DeciHz | {6,2,1,3,2,0} |
| mginputFrequency_3 | DeciHz | {6,2,1,3,3,0} |
| mginputMinimumVoltage | | {6,2,1,4,0} |
| mginputMaximumVoltage | | {6,2,1,5,0} |
| mginputCurrent_1 | DeciAmps | {6,2,1,6,1,0} |
| mginputCurrent_2 | DeciAmps | {6,2,1,6,2,0} |
| mginputCurrent_3 | DeciAmps | {6,2,1,6,3,0} |
| upsmgInputBadStatus | | {6,3,0} |
| upsmgInputLineFailCause | | {6,4,0} |
| upsmgOutputPhaseNum | | {7,1,0} |
| mgoutputPhaseIndex_1 | | {7,2,1,1,1,0} |
| mgoutputPhaseIndex_2 | | {7,2,1,1,2,0} |
| mgoutputPhaseIndex_3 | | {7,2,1,1,3,0} |
| mgoutputVoltage_1 | deciVolts | {7,2,1,2,1,0} |
| mgoutputVoltage_2 | deciVolts | {7,2,1,2,2,0} |
| mgoutputVoltage_3 | deciVolts | {7,2,1,2,3,0} |

| | | |
|---------------------------|--------------|---------------|
| mgoutputFrequency_1 | deciHz | {7,2,1,3,1,0} |
| mgoutputFrequency_2 | deciHz | {7,2,1,3,2,0} |
| mgoutputFrequency_3 | deciHz | {7,2,1,3,3,0} |
| mgoutputLoadPerPhase_1 | % | {7,2,1,4,1,0} |
| mgoutputLoadPerPhase_2 | % | {7,2,1,4,2,0} |
| mgoutputLoadPerPhase_3 | % | {7,2,1,4,3,0} |
| mgoutputCurrent_1 | deciAmps | {7,2,1,5,1,0} |
| mgoutputCurrent_2 | deciAmps | {7,2,1,5,2,0} |
| mgoutputCurrent_3 | deciAmps | {7,2,1,5,3,0} |
| upsmgOutputOnBattery | 1(yes) 2(no) | {7,3,0} |
| upsmgOutputOnByPass | 1(yes) 2(no) | {7,4,0} |
| upsmgOutputUtilityOff | 1(yes) 2(no) | {7,7,0} |
| upsmgOutputInverterOff | 1(yes) 2(no) | {7,9,0} |
| upsmgOutputOverLoad | 1(yes) 2(no) | {7,10,0} |
| upsmgOutputOverTemp | 1(yes) 2(no) | {7,11,0} |
| upsmgAgentIpAddress | | {12,1,0} |
| upsmgAgentSubnetMask | | {12,2,0} |
| upsmgAgentDefGateway | | {12,3,0} |
| upsmgAgentType | | {12,6,0} |
| upsmgAgentMibVersion | | {12,11,0} |
| upsmgAgentFirmwareVersion | | {12,12,0} |
| upsmgAgentCommUPS | 1(yes) 2(no) | {12,13,0} |

If the Environment Sensor is detected , the following information are managed.

| | | |
|---------------------------------|--------------------|--------------|
| upsmgEnvironAmbientTemp | 0.1 degré | {8,1,0} |
| upsmgEnvironAmbientHumidity | 0.1 % | {8,2,0} |
| upsmgEnvironmentNum | | {8,6,0} |
| upsmgEnvironmentIndex | | {8,7,1,1,1 } |
| upsmgEnvironmentComFailure | 1(yes) 2(no) | {8,7,1,2,1} |
| upsmgEnvironmentTemperature | 0.1 degré | {8,7,1,3,1} |
| upsmgEnvironmentTemperatureLow | 1(yes) 2(no) | {8,7,1,4,1} |
| upsmgEnvironmentTemperatureHigh | 1(yes) 2(no) | {8,7,1,5,1} |
| upsmgEnvironmentHumidity | 0.1 % | {8,7,1,6,1} |
| upsmgEnvironmentHumidityLow | 1(yes) 2(no) | {8,7,1,7,1} |
| upsmgEnvironmentHumidityHigh | 1(yes) 2(no) | {8,7,1,8,1} |
| upsmgEnvironmentInput1State | closed(1), open(2) | {8,7,1,9,1} |
| upsmgEnvironmentInput2State | closed(1), open(2) | {8,7,1,10,1} |

8.2.2 Table des TRAPS : (1.3.6.1.4.1.705.1.11)

SNMP traps are sent when alarms appears and disappears.

Level : 1:informational , 2:major, 3:critical

| MIB TRAP | Trap # | Level |
|-----------------------------|---------|---------|
| -upsmgBatteryFault | Trap 1 | Level 3 |
| -upsmgBatteryOK | Trap 2 | Level 1 |
| -upsmgAtLowBattery | Trap 5 | Level 3 |
| -upsmgFromLowBattery | Trap 6 | Level 1 |
| -upsmgChargerFault | Trap 7 | Level 3 |
| -upsmgChargerOK | Trap 8 | Level 1 |
| -upsmgOnBattery | Trap 11 | Level 2 |
| -upsmgReturnFromBattery | Trap 12 | Level 1 |
| -upsmgOnByPass | Trap 13 | Level 2 |
| -upsmgReturnFromByPass | Trap 14 | Level 1 |
| -upsmgUtilityFailure | Trap 17 | Level 2 |
| -upsmgUtilityRestored | Trap 18 | Level 1 |
| -upsmgOverLoad | Trap 21 | Level 3 |
| -upsmgLoadOK | Trap 22 | Level 1 |
| -upsmgOverTemperature | Trap 23 | Level 3 |
| -upsmgTemperatureOK | Trap 24 | Level 1 |
| -upsmgOffToStart | Trap 29 | Level 2 |
| -upsmgOffInProgress | Trap 31 | Level 3 |
| -upsmgCommunicationFailure | Trap 37 | Level 3 |
| -upsmgCommunicationRestored | Trap 38 | Level 1 |
| -upsmgRedundancyLost | Trap 65 | Level 2 |
| -upsmgRedundancyOK | Trap 66 | Level 2 |
| -upsmgProtectionLost | Trap 67 | Level 2 |
| -upsmgProtectionOK | Trap 68 | Level 2 |

If the Environment Sensor is detected , the following information are managed.:

| | | |
|---------------------------------|---------|---------|
| - upsEnvironmentComFailure | Trap 53 | Level 2 |
| - upsEnvironmentComOK | Trap 54 | Level 2 |
| - upsEnvironmentTemperatureLow | Trap 55 | Level 2 |
| - upsEnvironmentTemperatureHigh | Trap 56 | Level 2 |
| - upsEnvironmentTemperatureOK | Trap 57 | Level 2 |
| - upsEnvironmentHumidityLow | Trap 58 | Level 2 |
| - upsEnvironmentHumidityHigh | Trap 59 | Level 2 |
| - upsEnvironmentHumidityOK | Trap 60 | Level 2 |
| - upsEnvironmentInput1Closed | Trap 61 | Level 2 |

| | | |
|------------------------------|---------|---------|
| - upsEnvironmentInput1Open | Trap 62 | Level 2 |
| - upsEnvironmentInput2Open | Trap 64 | Level 2 |
| - upsEnvironmentInput2Closed | Trap 63 | Level 2 |

The level is used to select traps to be sent to the supervisor. This adjustment is available from the “Notified applications” page

9 Glossary

Bootp:

Protocol based on UDP used to allocate an IP address corresponding to an Ethernet card during the startup phase. Defined by the RCF 951

Community name:

Access key to access SNMP agent information

DHCP Dynamic Host Configuration Protocol

This IETF protocol enables remote, automatic, self-configuration of the IP addresses of a workstation.

DNS Domain Name Sevice1

The DNS protocol ensure correspondence between the name of a machine and its IP address

E-mail

Electronic means of transmitting messages and/or files.

Gateway

Interconnection equipment between networks with different conventions, to enable communication between them

HTML

(HyperText Markup Language) Language used to describe hypertext pages on the web.

HTTPS : is the secure version of HTTP, the communication protocol of the World Wide Web. It was invented by Netscape Communications Corporation to provide authentication and encrypted communication and is used in electronic commerce.

IP

Internet Protocol. Network layer protocol in the TCP/IP stack offering a no-connection inter-network service . The IP protocol offers functions for addressing, service type specification, fragmentation and re-assembling and security. Defined in RFC 791.

MIB MANAGEMENT INFORMATION BASE

- Group of software commands to control and administrate a device through the network. Each type of device (server, hub, PC, UPS, etc.) has its own MIB

NETWORK MANAGEMENT CARD

Communication cards to supervise UPS and communicate with Network Shutdown Module to insure power protection on servers

NETWORK MANAGEMENT PROXY

Communication software installed on a PC connected to the UPS to supervise it and communicate with Network Shutdown Module to insure power protection on servers

NMS NETWORK MANAGEMENT STATION (SNMP)

The dedicated PC or workstation is used on the company's networks to administrate all devices connected to the network. Data are transmitted using the SNMP protocol. Popular NMS systems include HP OpenView, IBM Tivoli, CA Unicenter, etc.

NSM : NETWORK SHUTDOWN MODULE

Protection software installed on a PC or server to protect it

NTP Network Time Protocol

Protocol to position a set of machines on a network at the same time.

Programmable outlet (controlled outlet):

Outlet that can be remote-switched on or off. UM-Client components enable management of such outlets.

REBOOT: To restart a system after an interruption.

- To perform an obstacle-free "reboot", it is essential that the system is correctly and carefully shut down beforehand.
- The reboot is usually automatic if the computer is re-supplied with electricity (from the utility or from the UPS).

RFC

Request for Comments. All documents defining internal Internet operation.

SNMP (SIMPLE NETWORK MANAGEMENT PROTOCOL)

Protocol used to remote-supervise, administrate and control devices connected to a company network.

SMTP (SIMPLE MAIL TRANSFER PROTOCOL)

Enables message transfer between e-mail servers or between the client and its server. It is based on the server's port 25. It is described in RFC 821

SSL (Secure Sockets Layers) is a protocol developed by Netscape Communications Corporation for securing data transmission in commercial transactions on the Internet. Using public-key cryptography, SSL provides server authentication, data encryption, and data integrity for client/server communications

Subnet mask:

Mask of bits used to identify and differentiate the network address and the equipment address in an IP address. Normally, the mask is automatically determined by the class of address, which defines in a unique manner the network part/equipment part division of the IP address.

- Class A: internet address: 255.0.0.0.
- Class B: internet address: 255.255.0.0.
- Class C: internet address: 255.255.255.0.

TCP/IP

Transmission Control Protocol/Internet Protocol. Common name of a series of protocols developed by the DOD in the US to help build Internet networks throughout the world.

Trap (SNMP) : This term describes an event that affects an MIB variable. Traps are sent to the manager, which is programmed to perform specific tasks upon reception of the traps.