



PL490/PL552
User Manual



Disclaimer

BenQ Corporation makes no representations or warranties, either expressed or implied, with respect to the contents of this document. BenQ Corporation reserves the right to revise this publication and to make changes from time to time in the contents thereof without obligation to notify any person of such revision or changes.

Copyright

Copyright 2016 BenQ Corporation. All rights reserved. No part of this publication may be reproduced, transmitted, transcribed, stored in a retrieval system or translated into any language or computer language, in any form or by any means, electronic, mechanical, magnetic, optical, chemical, manual or otherwise, without the prior written permission of BenQ Corporation.

Table of Contents

Safety warnings and precautions	1
Important safety instructions	2
Notes on the LCD panel of this display	2
Safety notice for remote control	3
Battery safety notice.....	3
BenQ ecoFACTS.....	4
Unpacking and Installation.....	5
Unpacking	5
Package Contents.....	5
Installation Notes	5
Mounting on a Wall	6
Mounting in Portrait Position	7
Parts and Functions.....	8
Control Panel.....	8
Input/Output Terminals.....	9
Remote control	11
Connecting External Equipment	15
Connecting External Equipment (DVD/VCR/VCD)	15
Connecting a PC.....	16
Connecting Audio Equipment.....	17
Connecting Multiple Displays in a Daisy-chain Configuration	18
IR connection.....	20
IR Pass-through Connection.....	20
Wire-connecting to Network	21
Operation	22
Watch the Connected Video Source.....	22
Change Picture Format.....	22
Choose your Preferred Picture Settings.....	22
Choose your Preferred Sound Settings	22

Play multimedia files via Local Area Network.....	23
Play multimedia files from USB device	26
Play options	27
Change your settings	29
Settings	30
USB device compatibility	41
Input Mode	43
Cleaning and Troubleshooting	45
Cleaning.....	45
Troubleshooting	46
Technical Specifications.....	48

Safety warnings and precautions



The lightning flash with arrowhead symbol, within an equilateral triangle, is intended to alert the user to the presence of uninsulated "dangerous voltage" within the product's enclosure that may be of sufficient magnitude to constitute a risk of electric shock to persons.



The exclamation point within an equilateral triangle is intended to alert the user to the presence of important operating and maintenance (servicing) instructions in the literature accompanying the appliance.

THIS EQUIPMENT MUST BE GROUNDED

To ensure safe operation, the three-pin plug must be inserted only into a standard three-pin power outlet which is effectively grounded through normal household wiring. Extension cords used with the equipment must have three cores and be correctly wired to provide connection to the ground. Wrongly wired extension cords are a major cause of fatalities.

The fact that the equipment operates satisfactorily does not imply that the power outlet is grounded or that the installation is completely safe. For your safety, if you are in any doubt about the effective grounding of the power outlet, please consult a qualified electrician.

- The mains plug of the power supply cord shall remain readily operable. The AC receptacle (mains socket outlet) shall be installed near the equipment and shall be easily accessible. To completely disconnect this equipment from the AC mains, disconnect the power cord plug from the AC receptacle.
- Do not place this display on an uneven, sloping or unstable surface (such as a trolley) where it may fall and cause damage to itself or others.
- Do not place this display near water, like a spa or pool, or in a position which will allow the splashing or spraying of water onto the display, like in front of an open window where rain water may enter.
- Do not install this display in a confined space without proper ventilation and air circulation, such as in a closed cabinet. Allow proper space around the display for dissipating heat inside. Do not block any openings and vents on the display. Overheating may result in hazards and electric shock.
- Installation of this display should only be performed by a qualified technician. Failure to install this display properly may cause injuries and damages to the personnels and the display itself. Check the installation regularly and maintain the display periodically to ensure the best working condition.
- Use only the accessories approved or recommended by the manufacturer to mount this display. Using wrong or unsuitable accessories may cause the display to fall and result in serious personal injuries. Make sure that the surface and fixing points are strong enough to sustain the weight of the display.
- To reduce the risk of electric shock, do not remove covers. No user serviceable parts inside. Refer servicing to qualified service personnel.
- To prevent personal injuries, mounting the display or installing desktop stands is required before use.

Important safety instructions

1. Read these instructions.
2. Keep these instructions.
3. Heed all warnings.
4. Follow all instructions.
5. Do not use this apparatus near water.
6. Clean only with dry cloth.
7. Do not block any ventilation openings. Install in accordance with the manufacturer's instructions.
8. Do not install near any heat sources such as radiators, heat registers, stoves, or other apparatus (including amplifiers) that produce heat.
9. Do not defeat the safety purpose of the polarized or grounding-type plug. A polarized plug has two blades with one wider than the other. A grounding-type plug has two blades and a third grounding prong. The wide blade or the third prong are provided for your safety. If the provided plug does not fit into your outlet, consult an electrician for replacement of the obsolete outlet.
10. Protect the power cord from being walked on or pinched particularly at plugs, convenience receptacles, and the point where they exit from the apparatus.
11. Only use attachments/accessories specified by the manufacturer.
12. Use only with the cart, stand, tripod, bracket, or table specified by the manufacturer, or sold with the apparatus. When a cart is used, use caution when moving the cart/apparatus combination to avoid injury from tip-over.
14. Unplug this apparatus during lightning storms or when unused for long periods of time.
15. Refer all servicing to qualified service personnel. Servicing is required when the apparatus has been damaged in any way, such as power-supply cord or plug is damaged, liquid has been spilled or objects have fallen into the apparatus, the apparatus has been exposed to rain or moisture, does not operate normally, or has been dropped.



Notes on the LCD panel of this display

- The Liquid Crystal Display (LCD) panel of this display has a very thin protective layer of glass which is liable to marking or scratching, and cracking if struck or pressured. The liquid crystal substrate is also liable to damage under excessive force or extreme temperatures. Please handle with care.
- The response time and brightness of the LCD panel may vary with the ambient temperature.
- Avoid placing the display in direct sun or where direct sun or spot lighting will shine onto the LCD panel, as the heat may damage the panel and the external casing of the display, and the bright light will make viewing the display more difficult than necessary.
- The LCD panel consists of individual pixels to display images and is manufactured according to the design specifications. While 99.9% of these pixels work normally, 0.01% of the pixels may remain constantly lit (in red, blue or green) or unlit. This is a technical limitation of the LCD technology and is not a defect.

- LCD screens, like plasma (PDP) and conventional CRT (Cathode Ray Tube) screens, are also susceptible to 'screen burn-in' or 'image retention' which can be found on the screen as visible fixed lines and shades. To avoid such damage to the screen, avoid displaying still images (like On-Screen Display menus, TV station logos, fixed/inactive text or icons) for more than two hours. Change the aspect ratio from time to time. Fill the entire screen with the image and eliminate the black bars whenever possible. Avoid displaying images in 4:3 aspect ratio over a long period of time, otherwise there may be visible burn marks on the screen as two vertical lines.
Note: Under certain circumstances, condensation may occur on the inner side of the cover glass, it's a natural phenomenon and will not affect the operation of the display. This condensation will usually disappear after around 30 minutes of normal operation.
- If display of a still image is required, it is recommended to enable pixel shift under the General settings.

Safety notice for remote control

- Do not put the remote control in the direct heat, humidity, and avoid fire.
- Do not drop the remote control.
- Do not expose the remote control to water or moisture. Failure to do so could result in malfunction.
- Confirm there is no object between the remote control and the remote sensor of the product.
- When the remote control will not be used for an extended period, remove the batteries.

Battery safety notice

The use of the wrong type of batteries may cause chemical leaks or explosion. Please note the following:

- Always ensure that the batteries are inserted with the positive and negative terminals in the correct direction as shown in the battery compartment.
- Different types of batteries have different characteristics. Do not mix different types.
- Do not mix old and new batteries. Mixing old and new batteries will shorten battery life or cause chemical leaks from the old batteries.
- When batteries fail to function, replace them immediately.
- Chemicals which leak from batteries may cause skin irritation. If any chemical matter seeps out of the batteries, wipe it up immediately using a dry cloth, and replace the batteries as soon as possible.
- Due to varying storage conditions, the battery life for the batteries included with your product may be shortened. Replace them within 3 months or as soon as you can after initial use.
- There may be local restrictions on the disposal or recycling of batteries. Consult your local regulations or waste disposal provider.

BenQ ecoFACTS

BenQ has been dedicated to the design and development of greener product as part of its aspiration to realize the ideal of the "Bringing Enjoyment 'N Quality to Life" corporate vision with the ultimate goal to achieve a low-carbon society. Besides meeting international regulatory requirement and standards pertaining to environmental management, BenQ has spared no efforts in pushing our initiatives further to incorporate life cycle design in the aspects of material selection, manufacturing, packaging, transportation, using and disposal of the products. BenQ ecoFACTS label lists key eco-friendly design highlights of each product, hoping to ensure that consumers make informed green choices at purchase. Check out BenQ's CSR Website at <http://csr.BenQ.com/> for more details on BenQ's environmental commitments and achievements.



Unpacking and Installation

Unpacking

- This product is packed in a carton, together with the standard accessories.
- Any other optional accessories will be packed separately.
- Due to the size and weight of this display it is recommended for two people to move it.
- After opening the carton, ensure that the contents are complete and in good condition.

Package Contents

Please verify that you received the following items with your package content:

- LCD display
- Remote control
- Power cord (1.8 m)
- Quick start guide
- VGA cable (1.0 m)
- HDMI cable (1.8 m)
- DP cable (1.8 m)
- Audio cable (1.8 m)
- IR Extender cable (1.8 m)
- RS232 cable (1.8 m)
- RS232 loop cable (1.8 m)
- Gap inspection pads (3 pieces)

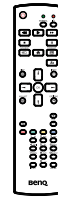

Remote Control



Power Cord



VGA Cable



HDMI Cable



DP Cable



Quick start guide



RS232 Cable



RS232 Loop Cable



IR Extender Cable



Audio Cable

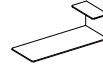

Gap inspection pads(x3)

*The supplied power cord varies depending on destination.



- For all other regions, apply a power cord that conforms to the AC voltage of the power socket and has been approved by and complies with the safety regulations of the particular country.
- You might like to save the package box and packing material for shipping the display.

Installation Notes

- Due to the high power consumption, always use the plug exclusively designed for this product. If an extended line is required, please consult your service agent.

- The product should be installed on a flat surface to avoid tipping. The distance between the back of the product and the wall should be maintained for proper ventilation. Avoid installing the product in the kitchen, bathroom or any other places with high humidity so as not to shorten the service life of the electronic components.
- The product can normally operate only under 5000m in altitude. In installations at altitudes above 3000m, some abnormalities may be experienced.

Mounting on a Wall

To mount this display to a wall, you will have to obtain a standard wall-mounting kit (commercially available). We recommend using a mounting interface that complies with TUV-GS and/or ULI678 standard in North America.

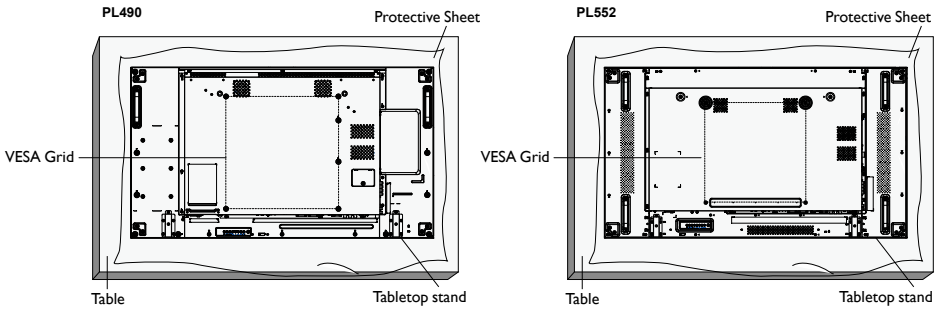

1. Lay a protective sheet on a table, which was wrapped around the display when it was packaged, beneath the screen surface so as not to scratch the screen face.
2. Ensure you have all accessories for mounting this display (wall mount, ceiling mount, table stand, etc).
3. Follow the instructions that come with the base mounting kit. Failure to follow correct mounting procedures could result in damage to the equipment or injury to the user or installer. Product warranty does not cover damage caused by improper installation.
4. For the wall-mounting kit, use M6 mounting screws (having a length 10 mm longer than the thickness of the mounting bracket) and tighten them securely.
5. Unit without base weight= 21.6 kg. The equipment and its associated mounting means still remain secure during the test. For use only with UL Listed Wall Mount Bracket with minimum weight/load: 64.8 kg.

VESA Grid

PL490/PL552	400(H) x 400(V) mm
--------------------	--------------------



To prevent the display from falling:

- For wall or ceiling installation, we recommend installing the display with metal brackets which are commercially available. For detailed installation instructions, refer to the guide received with the respective bracket.
- To lessen the probability of injury and damage resulting from fall of the display in case of earthquake or other natural disaster, be sure to consult the bracket manufacturer for installation location.

Ventilation Requirements for enclosure locating

To allow heat to disperse, leave space between surrounding objects as shown in the diagram below.

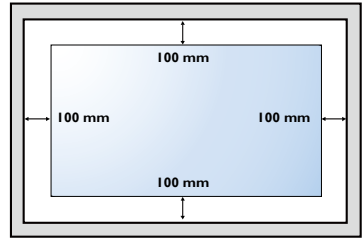

Mounting in Portrait Position

This display can be installed in portrait position.

1. Remove the table stand, if attached.
2. Rotate 90 degrees anticlockwise.

PL490

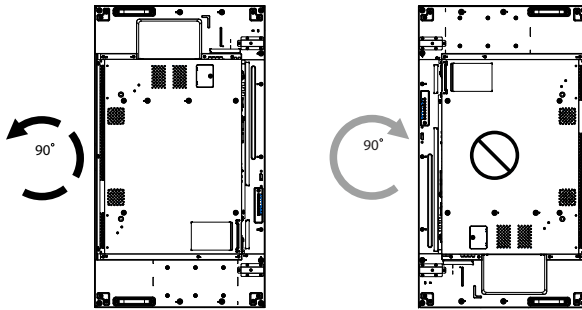

PL552

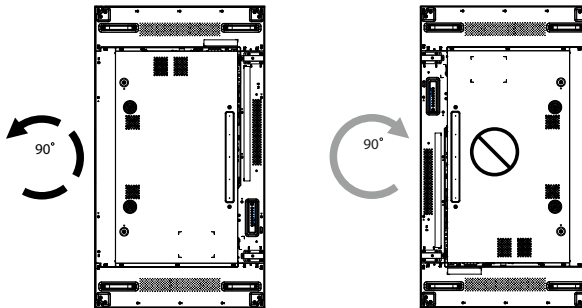

Parts and Functions

Control Panel

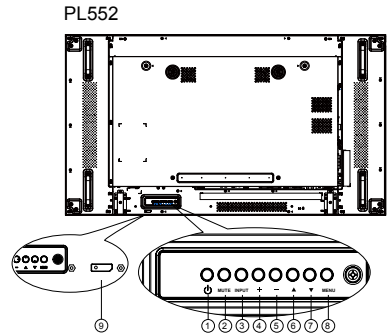
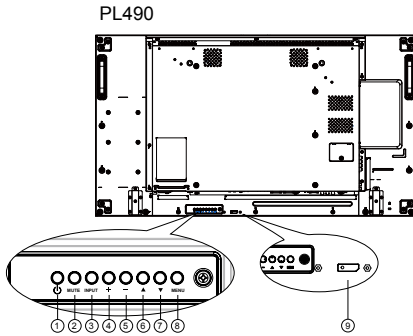

No.	Name	Description
1	Power button	Use this button to turn the display on or put the display to standby.
2	MUTE button	Switch the audio mute ON/OFF.
3	INPUT button	Choose the input source. • Used as OK button in the On-Screen-Display menu.
4	+ button	Increase the adjustment while OSD menu is on, or increase the audio output level while OSD menu is off.
5	- button	Decrease the adjustment while OSD menu is on, or decrease the audio output level while OSD menu is off.
6	▲ button	Move the highlight bar up to adjust the selected item while OSD menu is on.
7	▼ button	Move the highlight bar down to adjust the selected item while OSD menu is on.
8	MENU button	Return to previous menu while OSD menu is on, or to activate the OSD menu when OSD menu is off. • Receives command signals from the remote control.
9	Remote control sensor and power status indicator	Indicates the operating status of the display without OPS: - Lights green when the display is turned on - Lights red when the display is in standby mode - Lights amber when the display enters APM mode - When SCHEDULE is enabled, the light blinks green and red - If the light blinks red, it indicates that a failure has been detected - Lights off when the main power of the display is turned off

Input/Output Terminals

PL490

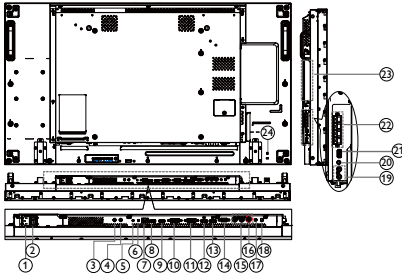

PL552

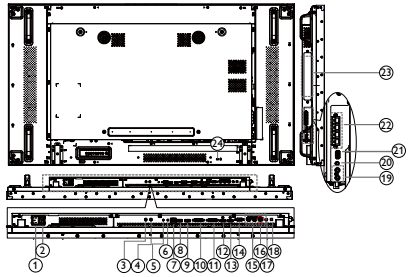

No.	Name	Description
1	AC IN	AC power input from the wall outlet.
2	MAIN POWER SWITCH	Switch the main power on/off.
3	IR IN	IR signal input / output for the loop-through function. 
4	IR OUT	<ul style="list-style-type: none"> This display's remote control sensor will stop working if the jack IR IN is connected. To remotely control your A/V device via this display, refer to page 20 for IR Pass Through connection.
5	RS232C IN	RS232C network input / output for the loop-through function.
6	RS232C OUT	
7	RJ-45	LAN control function for the use of remote control signal from control center.
8	HDMI1 IN	HDMI video/audio input.
9	HDMI2 IN	
10	DVI IN	DVI-D video input.
11	DVI OUT / VGA OUT	DVI or VGA video output.
12	DisplayPort IN	DisplayPort video input / output.
13	DisplayPort OUT	
14	VGA IN (D-Sub)	VGA video input.
15	COMPONENT IN (BNC)	Component YPbPr video source input.
16	Y/CVBS	Video source input.
17	PC LINE IN	Audio input for VGA source (3.5mm stereo phone).
18	SPEAKER SWITCH	Internal speaker on/off switch.
19	AUDIO IN	Audio input from external AV device (RCA).

20	AUDIO OUT	Audio output to external AV device.
21	USB PORT	Connect your USB storage device.
22	SPEAKERS OUT	Audio output to external speakers.
23	OPS SLOT	Slot for installing the optional OPS module.
24	SECURITY LOCK	Used for security and theft prevention.

Remote control

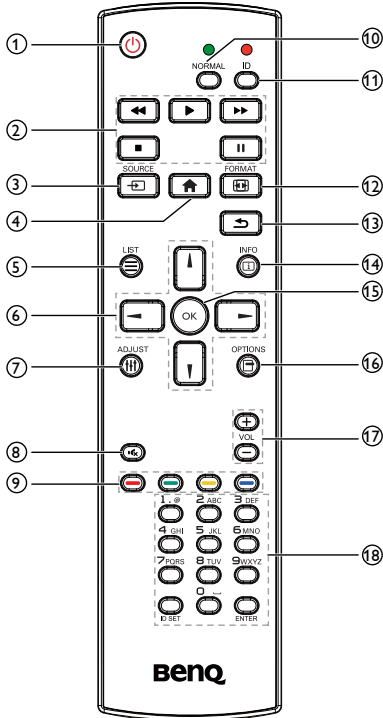

1 POWER button

Turn the display on or put the display to standby.

2 PLAY buttons

Control playback of media files.

3 SOURCE button

Choose input source. Press \uparrow or \downarrow button to choose from **USB, Network, HDMI 1, HDMI 2, Display Port, Card OPS, DVI-D, YPbPr, AV** or **VGA**. Press **OK** button to confirm and exit.

4 HOME button

Access the OSD menu.

5 LIST button

No function.

6 NAVIGATION buttons

Navigate through menus and choose items.

7 ADJUST button

To auto adjust for VGA input only.

8 MUTE button

Press to turn the mute function on/off.

9 COLOR buttons

Choose tasks or options.

10 NORMAL buttons

Switch to normal mode.

11 ID buttons

Switch to ID mode.

12 FORMAT button

Change zoom mode.

13 BACK button

Return to the previous menu page or exit from the previous function.

14 INFO button

Display information about current activity.

15 OK button

Confirm an entry or selection.

16 OPTIONS button

Access currently available options, picture and sound menus.

17 VOLUME button

Adjust volume.

18 NUMERIC buttons

Enter text for network setting, and set up ID for ID mode.

ID Remote Control

You can set the remote control ID when you want to use this remote control on one of several different displays.

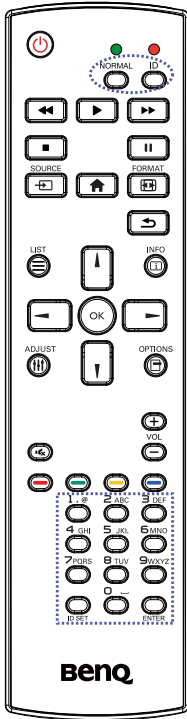

Press ID button. The red LED blinks twice.

1. Press ID SET button for more than 1 second to enter the ID Mode. The red LED lights up.
Press the ID SET button again will exit the ID Mode. The red LED lights off.

Press the digit numbers **0 ~ 9** to select the display you want to control.

For example: press **0** and **1** for display No. 1, press **1** and **1** for display No. 11.

The numbers available are from **01 ~ 255**.

2. Not pressing any button within 10 seconds will exit the ID Mode.
3. If an error pressing of buttons other than the digits occurred, wait 1 second after the red LED lights off and then lights up again, then press the correct digits again.
4. Press **ENTER** button to confirm. The red LED blinks twice and then lights off.



- Press **NORMAL** button. The green LED blinks twice, indicating the display is in normal operation.
- It is necessary to set up the ID number for each display before selecting its ID number.

Inserting the batteries in the remote control

The remote control is powered by two 1.5V AAA batteries.

To install or replace batteries:

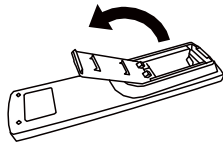

1. Buy two 1.5V AAA batteries.
2. Press and then slide the cover to open it

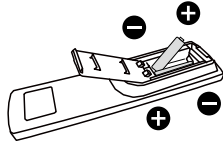

3. Align the batteries according to the (+) and (-) indications inside the battery compartment

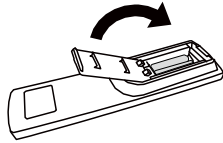

4. Replace the cover.



The incorrect use of batteries can result in leaks or bursting. Be sure to follow these instructions:

- Place "AAA" batteries matching the (+) and (-) signs on each battery to the (+) and (-) signs of the battery compartment.
- Do not mix battery types.
- Do not combine new batteries with used ones. It causes shorter life or leakage of batteries.
- Remove the dead batteries immediately to prevent them from liquid leaking in the battery compartment. Don't touch exposed battery acid, as it can damage your skin.



If you do not intend to use the remote control for a long period, remove the batteries.

Handling the remote control

- Do not subject to strong shock.
- Do not allow water or other liquid to splash the remote control. If the remote control gets wet, wipe it dry immediately.
- Avoid exposure to heat and steam.
- Other than to install the batteries, do not open the remote control.

Operating range of the remote control

Point the top of the remote control toward the display's remote control sensor(back side) when pressing a button.

Use the remote control within the range which is shown in the following table.

Operation Angle	RC operational distance
$\theta = 0^\circ$ (for H & V)	$\geq 8\text{m}$
$\theta = 20^\circ$ (for H & V)	$\geq 5\text{m}$
$\theta = 45^\circ$ (for H only)	$\geq 2\text{m}$

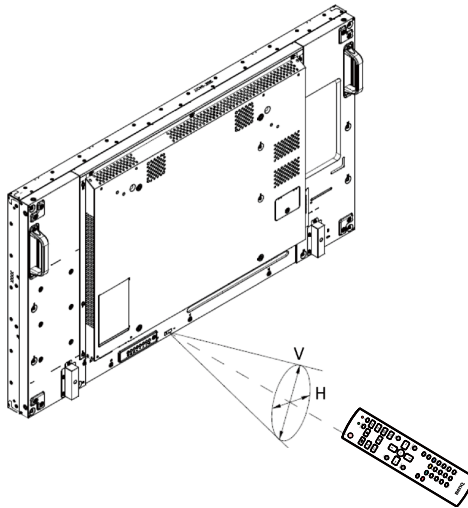

The remote control may not function properly when the remote control sensor on the display is under direct sunlight or strong illumination, or when there is an obstacle in the path of signal transmission.

Connecting External Equipment

Connecting External Equipment (DVD/VCR/VCD)

Using COMPONENT video input

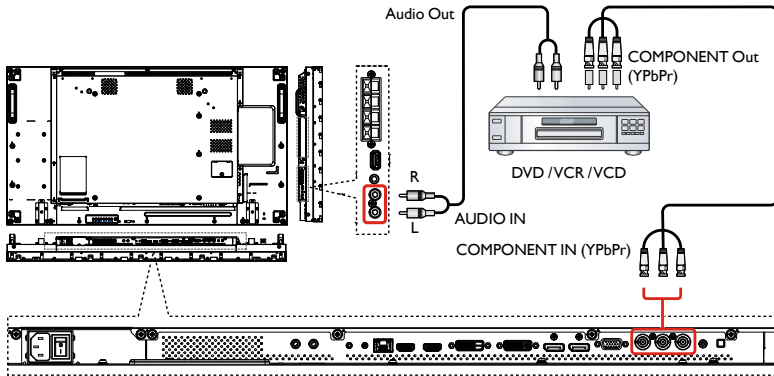

Using Video Source input

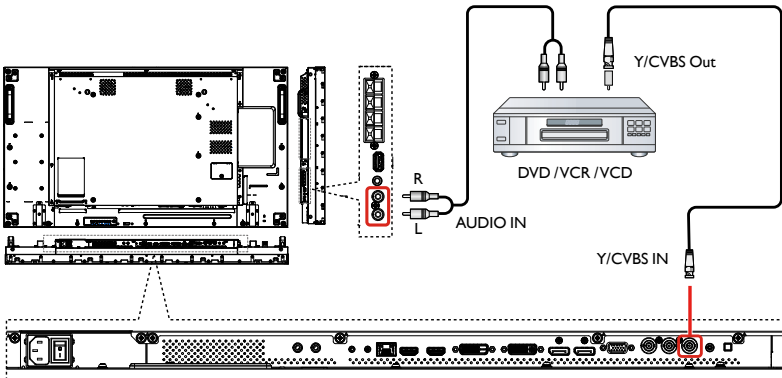

Using HDMI video input

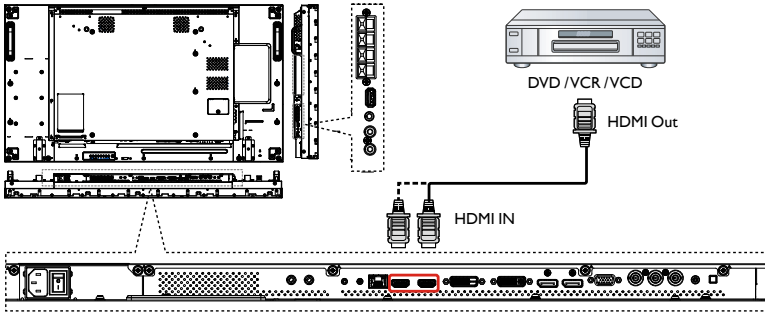

Connecting a PC

Using VGA input

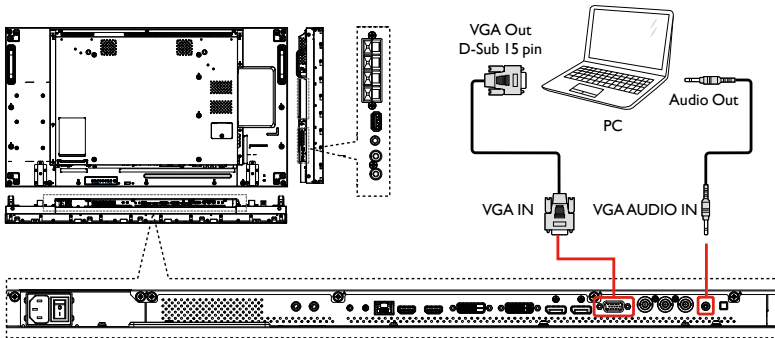

Using DVI input

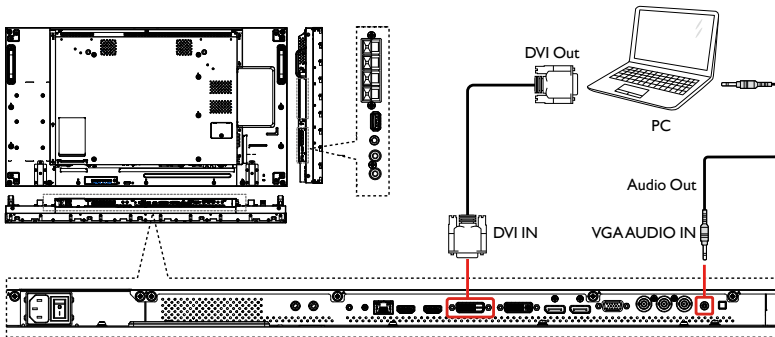

Using HDMI input

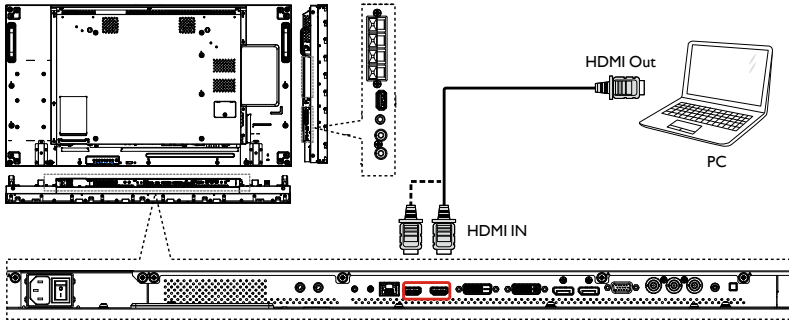

Using DisplayPort input

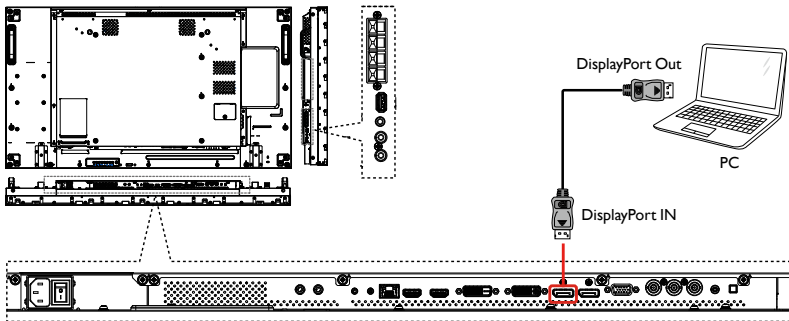

Connecting Audio Equipment

Connecting external speakers

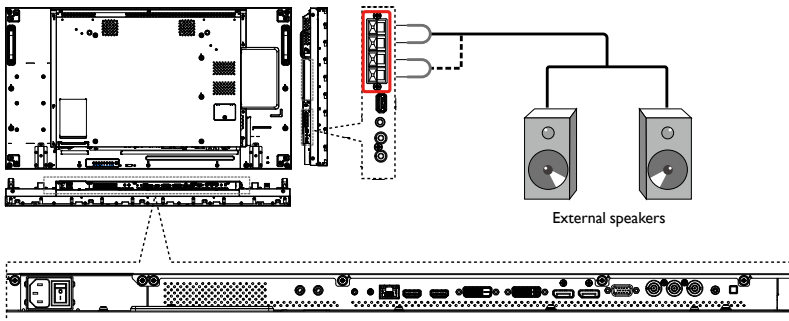

Connecting an external audio device

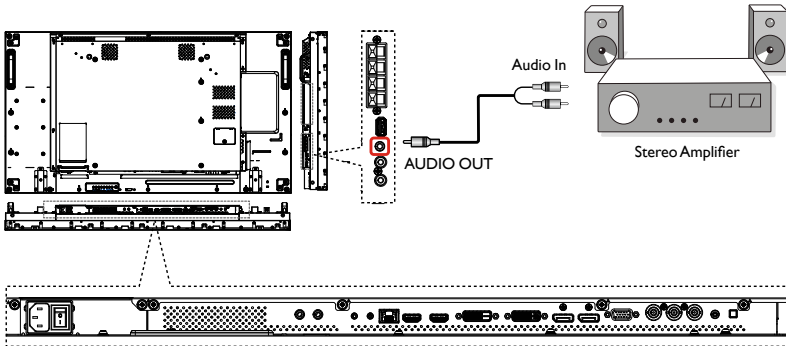

Connecting Multiple Displays in a Daisy-chain Configuration

You can interconnect multiple displays to create a daisy-chain configuration for applications such as a video wall.

Display control connection

Connect the RS232C OUT connector of DISPLAY 1 to the RS232C IN connector of DISPLAY 2.

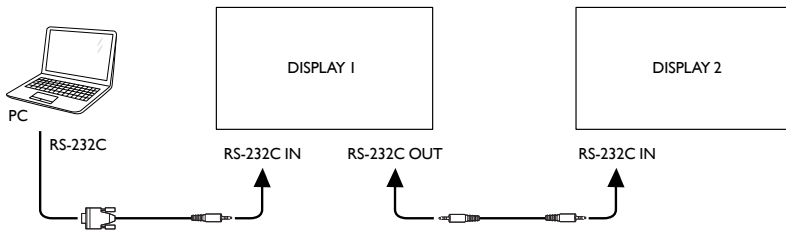

Digital video connection

Connect the DVI OUT /VGA OUT connector of DISPLAY 1 to the DVI IN connector of DISPLAY 2.

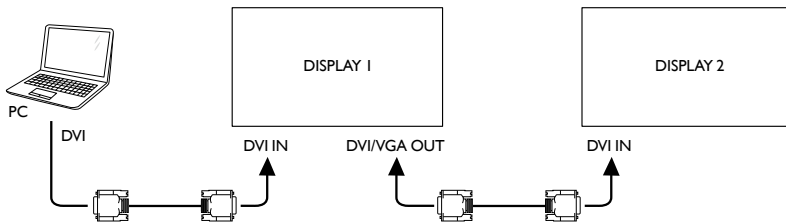

DVI Daisy chain to 5*5 without splitter, DVI with HDCP up to 7th.

Connect the DP OUT connector of DISPLAY 1 to the DP IN connector of DISPLAY 2.

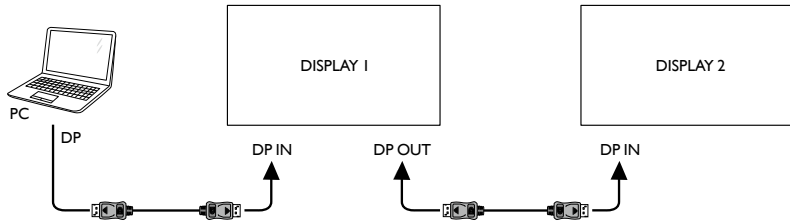

DP Daisy chain to 15*15 without splitter support 3840x2160@30Hz. DP with HDCP up to 7th.

Connect the HDMI OUT connector of DISPLAY 1 to the DVI IN connector of DISPLAY 2.

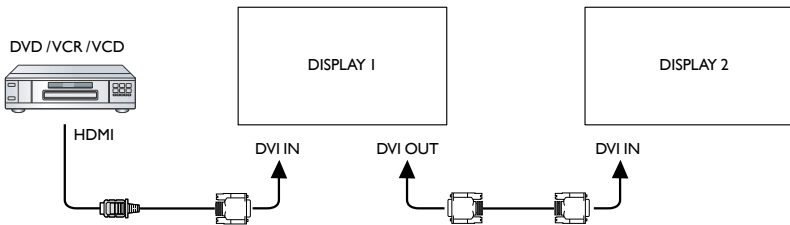

- HDMI up to 3840x2160@30Hz, HDMI with HDCP up to 7th.
- HDMI to DVI-I cable is not supplied.

Analog video connection

Connect the DVI OUT /VGA OUT connector of DISPLAY 1 to theVGA IN connector of DISPLAY 2.

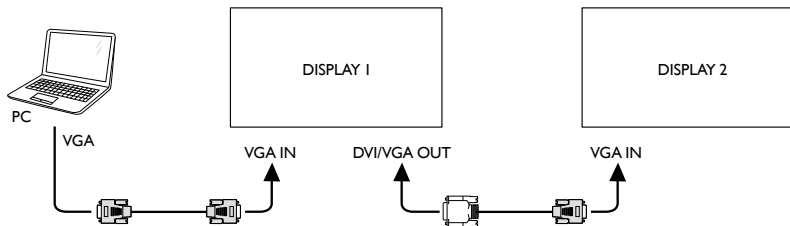

- Analog Daisy chain to 3*3 without splitter.
- DVI-I to VGA cable is not supplied.

IR daisy-chain Connection

Connect IR Sensor Cable to DISPLAY 1, and connect the RS232C OUT connector of DISPLAY 1 to the RS232C IN connector of DISPLAY 2.

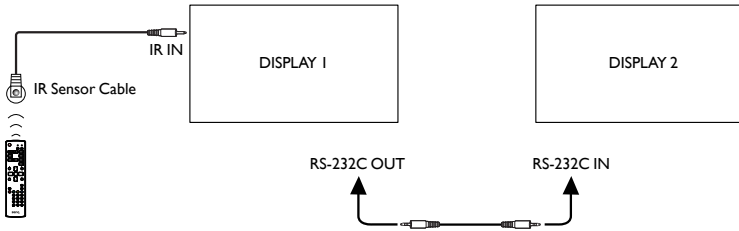

IR connection

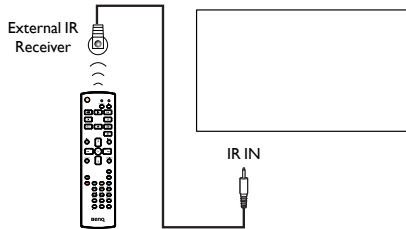

This display's remote control sensor will stop working if the **IR IN** is connected.

IR Pass-through Connection

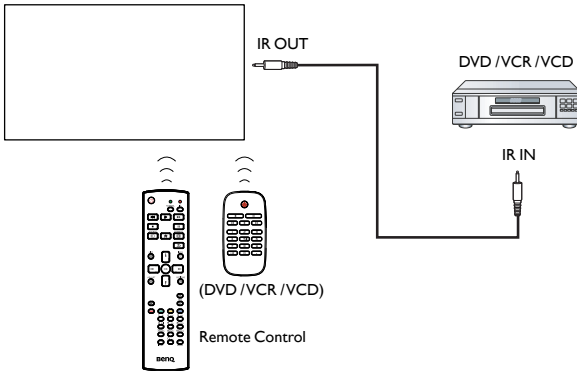

Wire-connecting to Network

If you connect this display to a home network, you can play photos, music and videos from your computer. See [Play multimedia files via Local Area Network on page 23](#) for more detail.

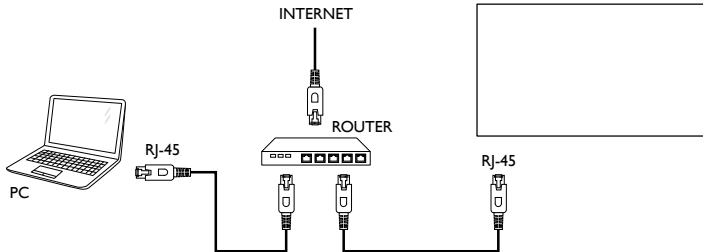

To setup the network:

1. Switch on the router and switch on its DHCP setting.
2. Connect the router to this display with an Ethernet cable.
3. Press **HOME** button to display the OSD menu.
4. Press **▲** or **▼** button to select the menu item **Network setting**. Press **OK** button to enter its submenu.
5. Press **▲**, **▼**, **◀**, **▶** or number button to adjust its value. Press **OK** button to confirm.



Connecting with a shielded CAT-5 Ethernet cable to comply with the EMC directive.



Operation



The control button described in this section is mainly on the remote control unless specified otherwise.

Watch the Connected Video Source



See [page 15](#) for external equipments connection.

1. Press  **SOURCE** button.
2. Press  or  button to choose a device, then press **OK** button.





Change Picture Format

You can change the picture format to suit the video source. Each video source has its available picture formats.





The available picture formats depend on the video source:

1. Press  **FORMAT** button.
2. Press  or  button to choose a picture format, then press **OK** button.
 - **Auto zoom**: Enlarge the picture to fill the screen. Recommended for minimal screen distortion but not for **HD** or **PC**.
 - **Movie expand 16:9**: Scale 4:3 format to 16:9. Not recommended for **HD** or **PC**.
 - **Wide screen**: Shows wide screen format content unstretched. Not recommended for **HD** or **PC**.
 - **Unscaled**: Provide maximum detail for **PC**. Only available when **PC** mode is selected in the **Picture** menu.
 - **4:3**: Display the classic 4:3 format.

Choose your Preferred Picture Settings

1. While this display is playing video source, press  **ADJUST** button.
2. Press  or  button to choose Picture style , then press **OK** button.
3. Press  or  button to choose an option, then press **OK** button:
 - **Personal**: Apply your personalized picture settings.
 - **Vivid**: Rich and dynamic settings, ideal for daytime viewing.
 - **Natural**: Natural picture settings.
 - **Standard**: Default settings that suit most environments and types of video.
 - **Movie**: Ideal settings for movies.
 - **Photo**: Ideal settings for photos.
 - **Energy saving**: Settings that conserve the most energy.

Choose your Preferred Sound Settings

1. While this display is playing video source, press  **ADJUST** button.
2. Press  or  button to choose **Sound style** , then press **OK** button.
3. Press  or  button to choose an option, then press **OK** button:
 - **Personal**: Apply your personalized sound settings.
 - **Original**: Settings that suit most environments and types of audio.

- **Movie:** Ideal settings for movies.
- **Music:** Ideal settings for listening to music.
- **Game:** Ideal settings for games.
- **News:** Ideal settings for spoken audio, such as the news.

Play multimedia files via Local Area Network

To play files via Local Area Network, you will need:

1. A wired home network, connected with a Universal Plug and Play (uPnP) router.
2. Optional: A LAN cable that connects your display to your home network.
3. A media server running on your computer.
4. Appropriate settings on your computer firewall to allow you to run the media server.
5. Support format
 - **Picture:** JPEG, PNG or BMP.
 - **Sound:** LPCM, MP3, AAC or WMA.
 - **Video:** MPEG2, MPEG-4 or WMV.
6. Display quality depends on network bandwidth.

Set up the network

1. Connect your display and the computer to the same home network. See illustration below to connect your display to a network.
2. Switch on your computer and the router.
 - **Single display setup:**

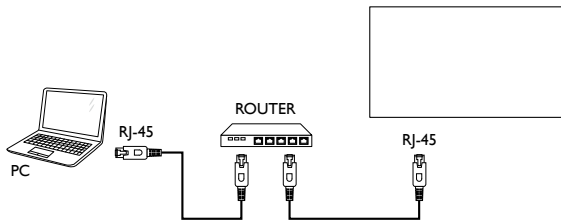

• Multiple display setup:

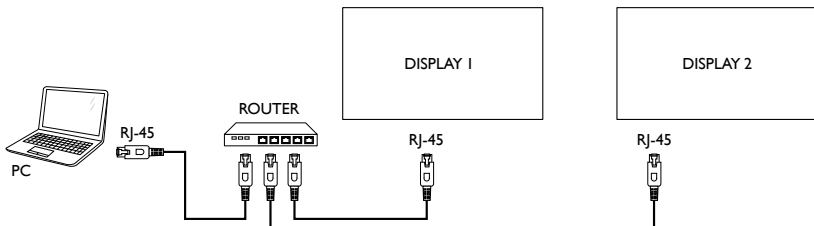

If the apparatus does not return to DLNA mode due to external electrical disturbances (e.g. electrostatic discharge), user intervention is required.

Set up media sharing

1. Install a media server on your computer to share media files. These are some media servers:
 - For **PC**: Windows Media Player 11 (or higher) or TVersity
 - For **Mac**: Twonky
2. Switch on media sharing on your computer using the media server. For more information on how to set up the media server, refer to the website of the media server.

How to use DLNA-DMP

1. Please connect display and your PC to the same router via RJ-45.
2. Run windows media player. Set stream handling as public sharing.

Play files from display

1. Press SOURCE button, choose **network** and press **OK** button.
2. Now, you can see all the PC's connected to the same router on the screen. Choose the right one.
3. Press **↓** and **→** to choose the directory and files to play.
4. You can connect up to 4 displays to the same PC and play same media stream.

We suggest to use DLNA-DMP function via wired network for the sake of higher security and sufficient network bandwidth.

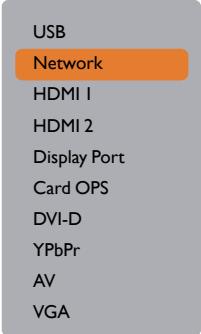

 The folder name and file name must be in English.

How to use DLNA-DMR from PC

1. Press **HOME** button, Choose **Network Settings** and press **OK**.

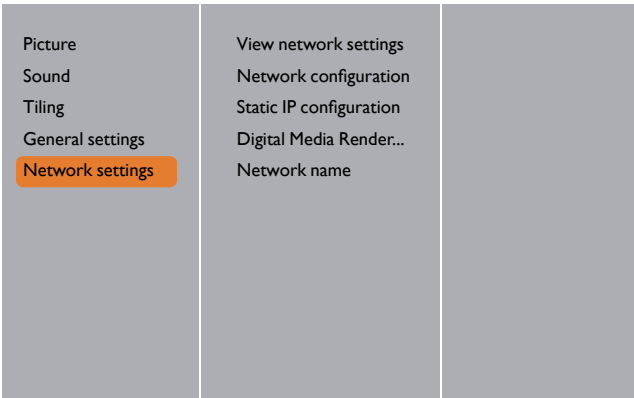

2. Set **DMR** as **ON**.

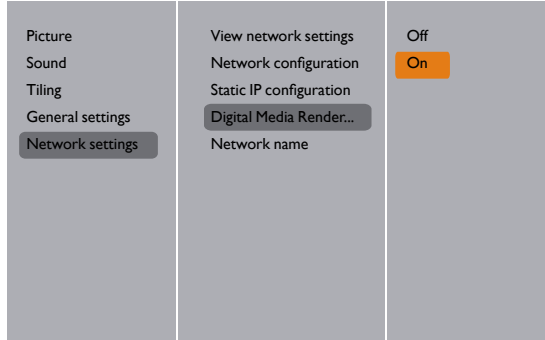

3. Set the name of your display.

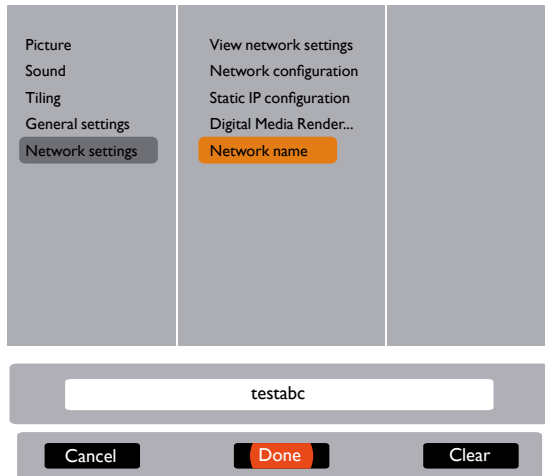

4. Press **SOURCE** button, choose **network** and press **OK** button.
5. On your PC, go to **Network and Sharing Center**, and click **Choose homegroup and sharing options**.
6. Check the media formats. Then, click **Choose media streaming options....**
7. Go to **Advanced sharing settings**, and check **Turn on network discovery**.
8. Now, go to the directory of your media files. Choose the media file by right click. On the submenu from **Play To**, You can find all displays connected to your network. Choose the display, and click the media file to play.

Play files

1. Press  **SOURCE** button.
2. Choose **Network**, and press **OK** button.
3. Choose a file from the content browser, and press **OK** button to start playing.
4. Press the **PLAY buttons** on the remote control to control playing.







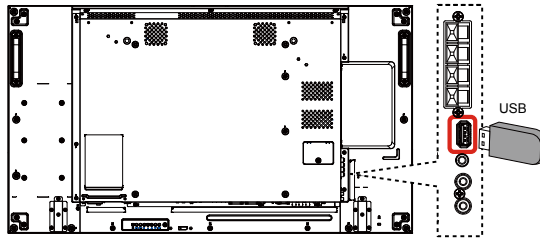

- Choose the top bar to filter your files by type.
- Choose **Sort** to arrange the files by album name, artist, or other fields.
- To clear the list of offline media servers, press  **OPTIONS** button. Then, choose **Clear offline servers** and press **OK** button.





Play multimedia files from USB device

1. Connect your USB device to the USB port on the display.



2. Press  **SOURCE** button, choose **USB**, and press **OK** button.
3. The connected USB device is detected automatically for all its playable files, which will be automatically sorted into 3 types:  **Music**,  **Movie**, and  **Photo**.

Press  **BACK** button to go up to the top layer in the screen. Press  or  button to choose the file type. Press **OK** button to enter its play list.

4. Choose the file you want. Press **OK** button to start playing.
5. Follow the on-screen instruction to control the play option.
6. Press **PLAY buttons** (    ) to control playing.

USB









Network
HDMI 1
HDMI 2
Display Port
Card OPS
DVI-D
YPbPr
AV
VGA

Play options

Playing music files

1. Choose  **Music** in the top bar.





2. Choose one music track, and press **OK** button.
 - To play all the tracks in a folder, choose one music file. Then, press  to **Play All**.
 - To skip to the next or previous track, press  or  button.
 - To pause the track, press **OK** button. Press **OK** button again to resume playback.
 - To skip backward or forward 10 seconds, press  or  button.
 - To search backward or forward, press  or  button, press repeatedly to toggle between different speeds.
 - To stop the music, press  button.

Music options

While you play music, press  **OPTIONS** button, then press **OK** button to choose an option:

- **Shuffle**: Enable or disable random play of tracks.
- **Repeat**: Choose **Repeat** to play a track or an album repeatedly, or choose **Play once** to play a track once.









To view information about a song (for example, title, artist or duration), choose the song, then press  **INFO** button. To hide the information, press  **INFO** button again.

Playing movie files

1. Choose  **Movie** in the top bar.



2. Choose a video, and press **OK** button.
 - To play all the videos in a folder, choose one video file. Then, press  to **Play All**.
 - To pause the video, press **OK** button. Press **OK** button again to resume playback.
 - To skip backward or forward 10 seconds, press  or  button.
 - To search backward or forward, press  or  button, press repeatedly to toggle between different speeds.
 - To stop the video, press  button.

Movie options

While playing video, press  **OPTIONS** button, then press **OK** button to choose an option:

- **Subtitles:** Choose the available subtitle settings.
- **Subtitle Language:** Choose the language for subtitles if available.
- **Shuffle:** Enable or disable random play of video files.
- **Repeat:** Choose **Repeat** to play the video file repeatedly or **Play once** to play the video file once.
- **Status:** To view information about a video (for example, played position, duration, title, or date).

Playing photo files



1. Choose  Photo in the top bar:



2. Choose a photo thumbnail, then press **OK** button.

Start a slideshow

If there are multiple photos in a folder, choose a photo. Then, press  to **Play All**.

- To skip to the previous or next photo, press  or  button, and then press **OK** button.
- To stop the slideshow, press  button.

Slideshow options

While you play a slideshow, press  **OPTIONS** button, then press **OK** button to choose an option:

- **Shuffle:** Enable or disable random display of pictures in the slideshow.
- **Repeat:** Choose **Repeat** to watch a slideshow repeatedly or **Play once** to watch once.
- **Slideshow Time:** Choose the displaying time for each photo in the slideshow.
- **Slideshow Transitions:** Choose the transition from one photo to the next.

Change your settings

Using the remote control:

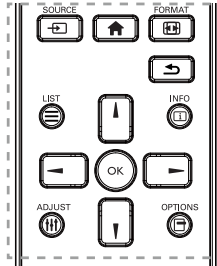

1. Press **HOME** button to display the OSD menu.
2. Press **▲, ▼, ◀** or **▶** button to choose its menu item or to adjust its value. Press **OK** button to confirm.
3. Press **BACK** button to go back to the previous menu layer.
4. Press **HOME** button to exit the OSD menu.

Using the display's control buttons

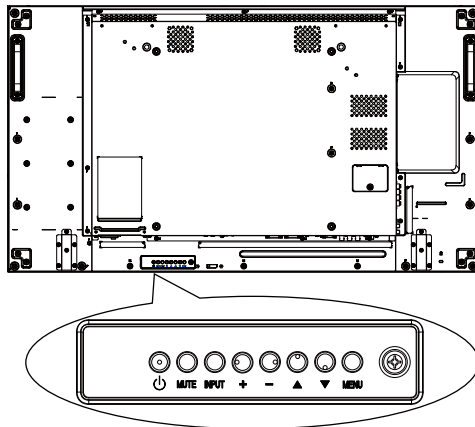

1. Press **MENU** button to display the OSD menu.
2. Press **▲, ▼, +** or **-** button to choose menu item or adjust its value.
3. Press **INPUT** button to confirm menu selection and enter its submenu.
4. Press **MENU** button to exit the OSD menu.

Settings

Picture

Picture	Picture style
Sound	Restore style
Tiling	Backlight
General settings	Colour
Network settings	Sharpness
	Noise reduction
	MPEG artifact reduction
	Digital Crystal Clear
	Advanced
	Game or computer
	Format and edges



For Game or computer, the default is computer mode (PC timing). You can switch to game mode to retrieve more functions.

Name	Description
Picture style	Choose a predefined picture setting under Game mode (video timing).
Restore style	Restore the last-selected predefined picture setting.
Backlight	Adjust the brightness of this display's backlight. The luminance setting by "backlight" for Energy Star verification.
Colour	Adjust the colour saturation of the picture.
Sharpness	Adjust the sharpness of the picture under Game mode (video timing).
Noise reduction	Choose the amount of noise reduction for the picture under Game mode (video timing).
MPEG artifact reduction	Smoothen transitions and haziness in the digital picture under Game mode (video timing).
Digital Crystal Clear	Fine-tune each pixel to match surrounding pixels and produce a brilliant, high-definition image under Game mode (video timing). <ul style="list-style-type: none"> • Advanced sharpness: Enable superior sharpness, especially on lines and contours in the picture. • Dynamic contrast: Dynamically enhance the details in the dark, medium and light areas of the picture. • Colour enhancement: Dynamically enhance the vividness and details of colours. • DCR= 500,000:1

Advanced	<p>Access advanced settings such as gamma, tint, video contrast and so on.</p> <ul style="list-style-type: none"> • Gamma: Adjust the non-linear setting for picture luminance and contrast. • Tint: Change the colour balance. • Custom tint: Customize colour balance setting. Only available if Tint → Custom is chosen. • Video contrast: Adjust video contrast. • Brightness: Adjust screen brightness. • Hue: Adjust screen hue.
Game or computer	<p>When viewing content from a connected game console, choose Game to apply game settings. When a computer is connected through HDMI, choose Computer.</p> <p>Make sure that Format and edges → Picture format → Unscaled is selected so as to view maximum detail.</p>
Format and edges	<ul style="list-style-type: none"> • Picture format: Change the picture format. <p>See page 22 for the descriptions about Picture format.</p>

Sound

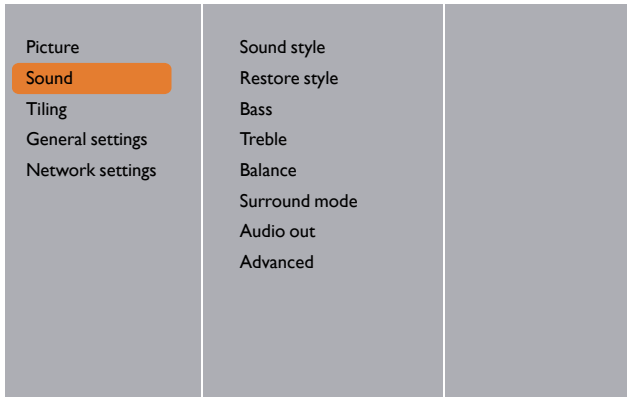

Name	Description
Sound style	Access predefined sound settings.
Restore style	Restore the last-selected predefined sound setting.
Bass	Adjust to increase or decrease lower-pitched sounds.
Treble	Adjust to increase or decrease higher-pitched sounds.
Balance	Adjust to emphasize left or right audio output balance.
Surround mode	Enhance your audio experience.
Audio out	Adjust audio output volume.

Advanced	<p>Access advanced settings to enhance your audio experience.</p> <ul style="list-style-type: none"> • Auto volume leveling: Enable the reduction of sudden volume changes. • Speaker settings: Turn on or off the internal speakers. • Clear sound: Enhance sound quality. • Audio out format: Choose the type of audio output through the digital audio output connector. (HDMI only) • Audio out delay: Automatically sync the image on this display to the audio from a connected home theatre. • Audio out offset: Adjust the setting for audio output delay. Available if Audio out delay is switched on.
-----------------	--

Tiling

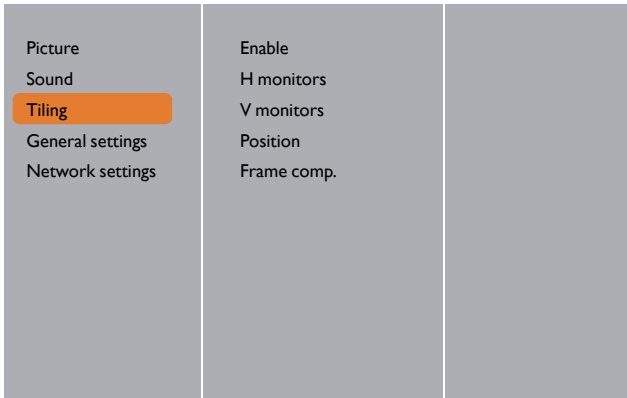

With this function you can create a single large-screen matrix (video wall) that consists of up to 225 sets of this display (**up to 15-sets on the vertical and 15-sets on the horizontal sides**).

Name	Description
Enable	Choose to On or Off the Tiling function. If On, the display will apply the settings in H monitors, V monitors, Position, and Frame comp.
H monitors	Adjust displays on the horizontal side.
V monitors	Adjust displays on the vertical side.

Position

Adjust the position of this display in the screen matrix.

Example: 2 x 2 screen matrix (4 displays)

H monitors = 2 displays

V monitors = 2 displays

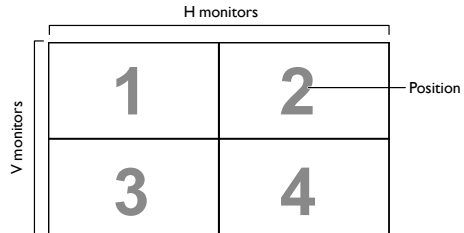

Example: 5 x 5 screen matrix (25 displays)

H monitors = 5 displays

V monitors = 5 displays

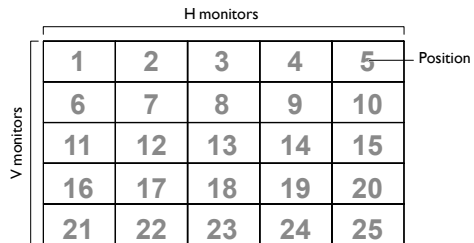
**Frame comp.**

Choose to turn the frame compensation function on or off. If selected **On**, the display will adjust the image to compensate for the width of the display bezels in order to accurately display the image.

General settings

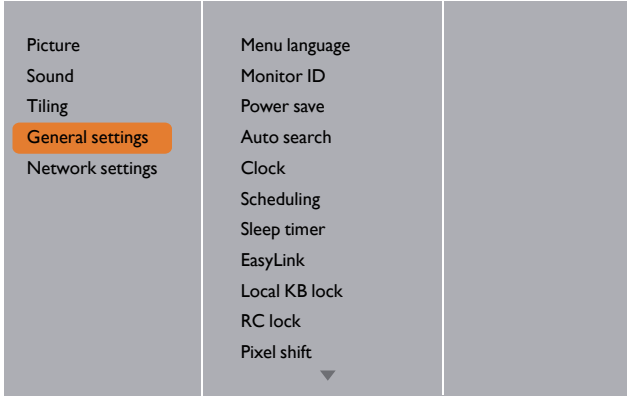

Name	Description
Menu language	Choose language used for OSD menus.
Monitor ID	Adjust the ID number for controlling the display via the RS232C connection. Each display must have a unique ID number when multiple sets of this display are connected. Monitor ID number range is between 1 to 255. The default setting is 1.
Power save	Set this display to reduce the power consumption automatically.
Auto search	Choose to let this display detect and display available signal sources automatically.
Clock	Set the current date and time for the display's internal clock.
Scheduling	<p>This function allows you to program up to 7 different scheduled time intervals for this display to activate.</p> <p>You can set:</p> <ul style="list-style-type: none"> • Which input source the display will use for each scheduled activation period. • The time for the display to turn on and turn off. • The days in a week for the display to activate.  <ul style="list-style-type: none"> • We recommend you to set up current date and time in the Clock menu before using this function. • After changing the Clock option in the General settings menu, you need to set this Scheduling again. • Need to set {On time} and {Off time} for each schedule. • Schedule will activate from {On time} after setting. It won't activate on {Off time}.

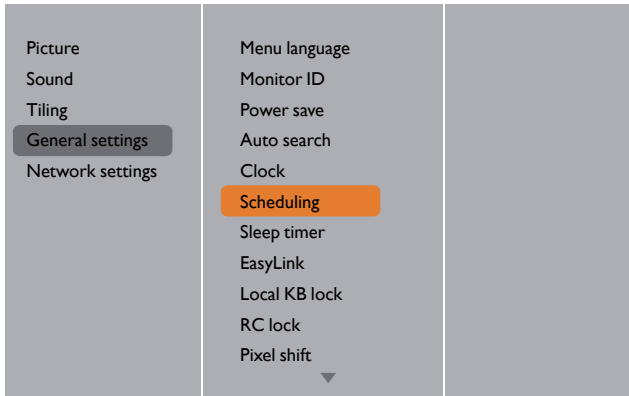

1. There are 7 schedule can be set. Go to **Status** and choose **On**.

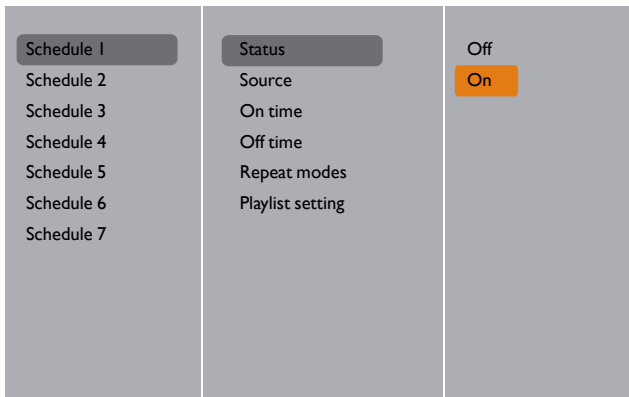

2. Go to **Source** and choose input source. If **Source** → **USB** is chosen. You need to set playlist.

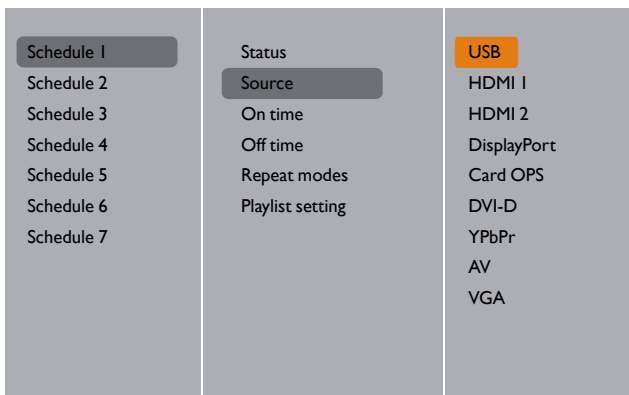

3. Set **On time**.

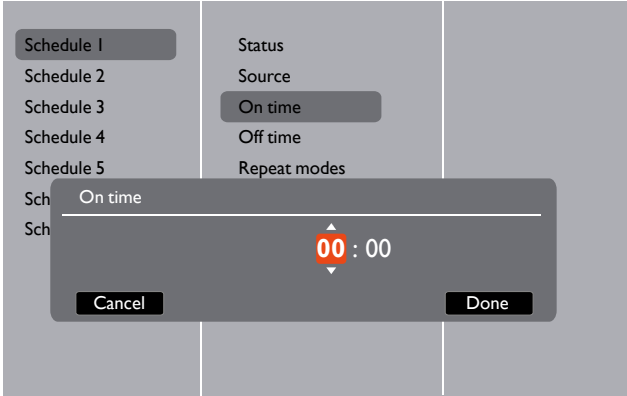

4. Set **Off time**.

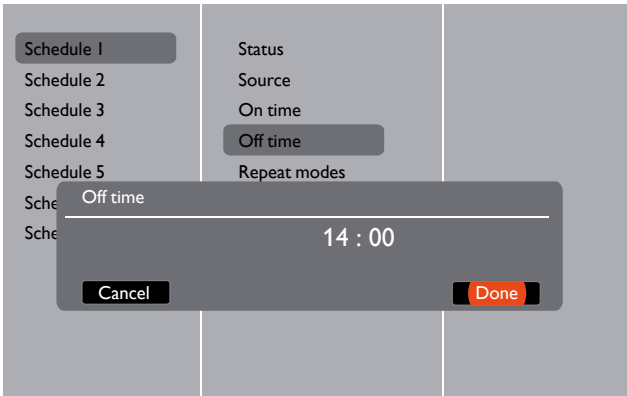

5. Go to **Repeat modes** and choose.

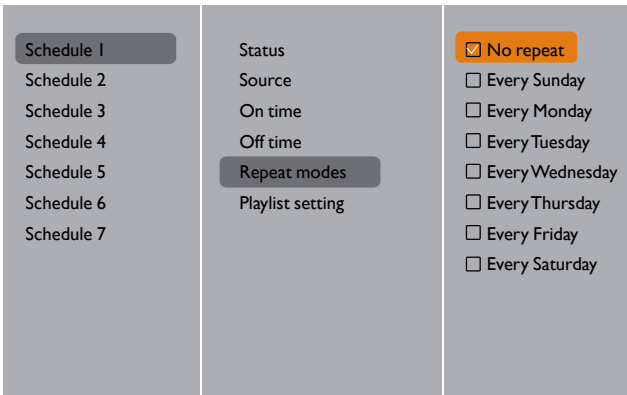

6. If **Source → USB** is chosen. Go to **Playlist setting**.

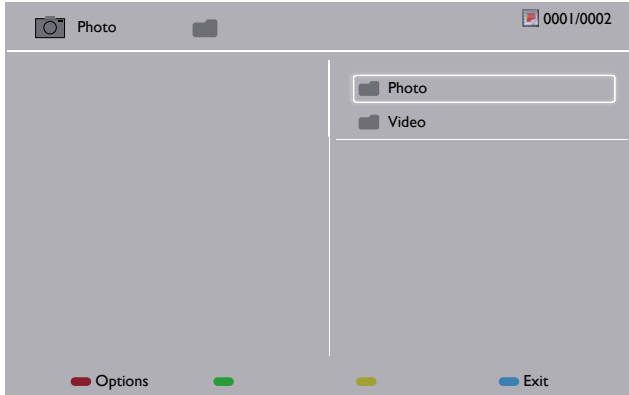



- Press **↓** / **↑** buttons to choose files.
- Press **←** / **→** buttons to switch Playlist and File Manager.
- Press **OK** button to set or clear the playlist.



7. To save the playlist, press **Options** and choose **Save list**.



- Each Playlist supports up to 30 files.
- Playlist will not be cleared after **Factory settings**. You have to manually remove the files or delete `usb_schedulinglist.txt` in the USB.

Name	Description
Sleep timer	Switch off this display after a specified time.
EasyLink	Connect and control your HDMI-CEC compliant devices through HDMI port to this display with the same remote control. Only support On/Off.
Auto adjust	Use this function to automatically optimize the display of VGA input image.  This item is functional for VGA input only.

Local KB lock	<p>Choose to enable or disable the keyboard (control buttons) function of the display.</p> <ul style="list-style-type: none"> • Unlock: Enable the keyboard function. • Lock all: Lock all keyboard function. • Lock but volume: Disable all the keyboard function except the — and + button. • Lock but power: Disable all the keyboard function except the ⏻ button. • Lock all expect volume and power: Disable all the keyboard function except the —, + and ⏻ button:
RC lock	<p>Choose to enable or disable the button function of the remote control.</p> <ul style="list-style-type: none"> • Unlock: Enable the keyboard function. • Lock all: Lock all keyboard function. • Lock but volume: Disable all the keyboard function except the — and + button. • Lock but power: Disable all the keyboard function except the ⏻ POWER button. • Lock all expect volume and power: Disable all the keyboard function except the — + and ⏻ POWER button: <p> To disable the lock function from Local KB lock or -RC lock item, press buttons ⬆ and 1998 on the remote control.</p>
Pixel shift	<p>For video input sources, you may choose On to move the screen image automatically to protect the display from “burn-in” or “after-image” symptoms 30 seconds after not operating the display.</p>
Smart power	<p>Choose a backlight level to optimize dynamic power consumption and picture contrast.</p>
Wake on lan	<p>The options are: Off, Standard, Best Power, Best Picture.</p>
Switch on state	<p>Choose the display status used for the next time you connect the power cord.</p> <ul style="list-style-type: none"> • On - The display will turn on when the power cord is connected to a wall outlet. • Standby - The display will remain Standby when the power cord is connected to a wall outlet. • Last status - The display will return to the previous power status (on/off/standby) when removing and replacing the power cord.
LED	<p>Choose Off to turn off the indicator.</p>
Switch on delay	<p>Adjust the power-on delaying time (in seconds) allows a sequential powering-on for each display by their ID number when multiple displays are connected.</p>

Information OSD	<p>When you press  POWER button to turn on the display from standby mode or change the input signal, the information OSD is displayed on the upper left corner of the screen.</p> <p>Choose Off to turn off this function.</p>
Cooling Fan	<p>Select On to turn on the cooling fan all the time. Select Auto to turn on/off the cooling fan according to the display's temperature.</p>  <ul style="list-style-type: none"> • The default Auto option will start running the cooling fan if the temperature of 60°C (140°F) is reached. • A temperature-warning message will be shown on the screen if the temperature reaches 70°C (158°F). • After the temperature reaches 70°C (158°F), for three successive minutes and a temperature-waning message shown on the screen for 10 seconds, the display power will be shut down automatically while Power LED will be blinking red & green.
Network control port	<p>Choose the RS232 control form Card OPS or embedded RS232 in PD set.</p>
Factory settings	<p>Reset all your customized settings to the factory defaults.</p>  <p>Only monitor ID won't be reset.</p>

Network Settings

1. Press  **HOME** button, choose **Network Settings** and press **OK** button.

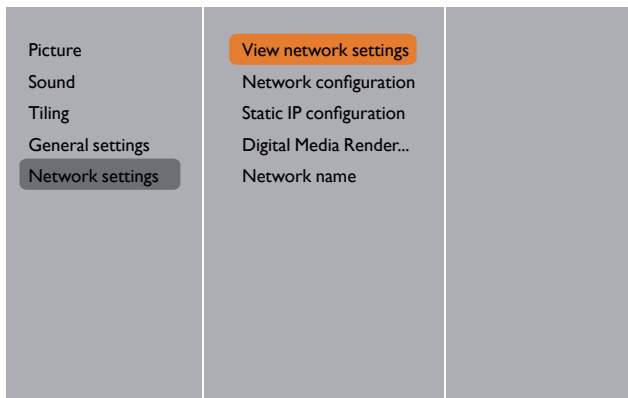

Name	Description
View network settings	View connected network status.
Network Configuration	<p>Network configuration: Choose how this display should assign addresses to the network resources.</p> <p>The user can choose DHCP & Auto IP (suggested) or Static IP.</p>

Static IP Configuration	Define IP address, Netmask, Gateway, DNS1 , and DNS2 for this display. If Network settings → Static IP is chosen.
Digital Media Renderer - DMR	Receive multimedia files from the connected device by your network.
Network name	In the multiple-display connection, you can rename each display for easy identification. Use the on-screen keyboard or the remote control keypad to enter the name.

USB device compatibility

USB Video Subtitle Formats (for language subtitles, etc.)

File Extensions	Container	Video codec	Maximum resolution	Max.Frame Rate (fps)	Max.Bit Rate (Mbps)	Audio codec	
.mpg mpeg .vob	PS	MPEG-1	1920x1080	25p,30p,50i,60i	30	MPEG-1 (L1&L2), MPEG-1,2,2.5 L3,	
		MPEG-2	1920x1080	25p,30p,50i,60i	30		
		MPEG-4 ASP	1920x1080	25p,30p,50i,60i	30		
		H.264	1920x1080	25p,30p,50p,60p,60i	30	AAC/HE- AAC(v1&v2), DVD-PCM,AC3	
.ts	TS	MPEG-2	1920x1080	25p,30p,50i,60i	30	MPEG-1 (L1&L2), MPEG-1,2,2.5 L3, AAC/HE-AAC (v1&v2), AC3,E-AC3, Dolby Pulse	
		MPEG-4 ASP	1920x1080	25p,30p,50i,60i	30		
		H.264	1920x1080	25p,30p,50p,60p,60i	30		
		MVC	1920x1080i@field rate=50, 60Hz 1920x1080p@frame rate=24, 25,30Hz 1280x720p@frame rate=50, 60Hz	-	30		
.ts .m2ts .mts .mt2	MaTS TTS	MPEG-2	1920x1080	25p,30p,50i,60i	30	MPEG-1 (L1&L2), MPEG-1,2,2.5 L3, AAC/HE-AAC (v1&v2), AC3,E-AC3, Dolby Pulse	
		MPEG-4 ASP	1920x1080	25p,30p,50i,60i	30		
		H.264	1920x1080	25p,30p,50p,60p,60i	30		
		MVC	1920x1080i @ field rate=50, 60Hz 1920x1080p @ frame rate=24, 25,30Hz 1280x720p @ frame rate=50, 60Hz	-	30		
.ts .m2ts .mts	AVCHD	MPEG-2	1920x1080	25p,30p,50i,60i	30	MPEG-1 (L1&L2), MPEG-1,2,2.5 L3, AAC/HE-AAC (v1&v2), AC3,E-AC3, Dolby Pulse	
		MPEG-4 ASP	1920x1080	25p,30p,50i,60i	30		
		H.264	1920x1080	25p,30p,50p,60p,60i	30		
.ts .m2ts .mts	AVCHD	MVC	1920x1080i@field rate=50, 60Hz 1920x1080p@frame rate=24, 25,30Hz 1280x720p @ frame rate=50, 60Hz	-	30	MPEG-1 (L1&L2), MPEG-1,2,2.5 L3, AAC/HE-AAC (v1&v2), AC3,E-AC3, Dolby Pulse	
		M4V	H.264	1920x1080	25p,30p,50p,60p,60i	30	AAC
		.ism/ Manifest .mpd	frag MP4	H.264	1920x1080	25p,30p,50p,60p,60i	30
MVC	1920x1080i@field rate=50, 60Hz 1920x1080p@frame rate=24, 25,30Hz 1280x720p @ frame rate=50, 60Hz			-	30		

.mp4	MP4	MPEG-4 ASP	1920x1080	25p,30p,50i,60i	30	AAC/HE-AAC(v1&v2), AC3,E-AC3,WMA, WMA-PRO
		H.264	1920x1080		30	
		MVC	1920x1080i@field rate=50, 60Hz 1920x1080p@frame rate=24, 25,30Hz 1280x720p @ frame rate=50, 60Hz	-	30	
		WMV9/VC1	1920x1080	30p,60i	30	
.mkv .mk3d	MKV	MPEG-4 ASP	1920x1080	25p,30p,50i,60i	30	MPEG-1(L1&L2), MPEG-1,2,2.5 L3, AAC/HE-AAC (v1&v2), AC3,E-AC3,WMA, WMA-PRO
		H.264	1920x1080		30	

USB Multimedia Formats

File Extensions	Container	Video codec	Maximum resolution	Frequency (kHz)	Max.Bit Rate (Mbps)	Audio codec
.mp3	MP3	-	-	48	384	MPEG-1,2,2.5 L3
.wma .asf	WMA (V2 up to V9.2)	-	-	48	192	WMA
.wma	WMA Pro	-	-	96	768	WMA,WMA Pro
.wav(PC)	LPCM	-	-	192	768	LPCM
.aif(mac) .aiff(mac)	LPCM	-	-	192	768	LPCM
.aac .mp4 .m4a	AAC	-	-	48	1024	AAC,HE-AAC(v1&v2)
.pls .m3u	Playlists	-	-	-	-	-
.m4a	M4A	-	-	48	1024	AAC,HE-AAC(v1&v2)



- Sound or video may not work if the contents have a standard bit rate/frame rate above the compatible Frame/sec listed in the table above.
- Video content with a Bit rate or Frame rate larger than the rate specified in the table above can cause choppy video during playback.

Input Mode

VGA Resolution:

Standard Resolution	Active Resolution		Refresh Rate	Pixel Rate	Aspect Ratio	Stand for Mode
	H Pixels	V Lines				
VGA	640	480	60 Hz	25.175 MHz	4:3	Video Graphic Array
			72 Hz	31.5 MHz		
			75 Hz	31.5 MHz		
WVGA	720	400	70 Hz	33.75 MHz	16:9	WideVideo Graphic Array
SVGA	800	600	60 Hz	40 MHz	4:3	SuperVGA
			75 Hz	49.5 MHz		
XGA	1024	768	60 Hz	65 MHz	4:3	Extended Graphic Array
			75 Hz	78.75 MHz		
WXGA	1280	768	60 Hz	79.5 MHz	5:3	Wide XGA
WXGA	1280	800	60 Hz	79.5 MHz	16:10	Wide XGA
SXGA	1280	960	60 Hz	108 MHz	4:3	Super XGA
SXGA	1280	1024	60 Hz	108 MHz	5:4	Super XGA
WXGA	1360	768	60 Hz	85.5 MHz	16:9	Wide XGA
WXGA	1366	768	60 Hz	85.5 MHz	16:9	Wide XGA
UXGA	1600	1200	60 Hz	162 MHz	4:3	Ultra XGA
HD 1080	1920	1080	60 Hz	148.5 MHz	16:9	HD 1080

SDTV Resolution:

Standard Resolution	Active Resolution		Refresh Rate	Pixel Rate	Aspect Ratio	Stand for Mode
	H Pixels	V Lines				
480i	720	480	29.97 Hz	13.5 MHz	4:3	Modified NTSC Standard
480p			59.94 Hz	27 MHz		
576i	720	480	25 Hz	13.5 MHz	4:3	Modified PAL Standard
576p			50 Hz	27 MHz		

HDTV Resolution:

Standard Resolution	Active Resolution		Refresh Rate	Pixel Rate	Aspect Ratio	Stand for Mode
	H Pixels	V Lines				
720p	1280	720	50 Hz	74.25 MHz	16:9	Normally DVB Mode
			60 Hz			
1080i	1920	1080	25 Hz	74.25 MHz	16:9	Normally ATSC Mode
			30 Hz			
1080p	1920	1080	50 Hz	148.5 MHz	16:9	Normally ATSC Mode
			60 Hz			

- The PC text quality is optimum in HD 1080 mode (1920 x 1080, 60Hz).
- Your PC display screen might appear different depending on the manufacturer (and your particular version of Windows).

- Check your PC instruction book for information about connecting your PC to a display.
- If a vertical and horizontal frequency-select mode exists, select 60Hz (vertical) and 31.5KHz (horizontal). In some cases, abnormal signals (such as stripes) might appear on the screen when the PC power is turned off (or if the PC is disconnected). If so, press the **INPUT** button to enter the video mode. Also, make sure that the PC is connected.
- When horizontal synchronous signals seem irregular in RGB mode, check PC power saving mode or cable connections.
- The display settings table complies to the IBM/VESA standards, and based on the analog input.
- The DVI support mode is regarded as same to the PC support mode.
- The best timing for the vertical frequency to each mode is 60Hz.

Cleaning and Troubleshooting

Cleaning

Caution When Using the Display

- Do not bring your hands, face or objects close to the ventilation holes of the display. The top of the display is usually very hot due to the high temperature of exhaust air being released through the ventilation holes. Burns or personal injuries may occur if any body parts are brought too close. Placing any object near the top of the display could also result in heat related damage to the object as well as the display itself.
- Be sure to disconnect all cables before moving the display. Moving the display with its cables attached may damage the cables and thus cause fire or electric shock.
- Disconnect the power plug from the wall outlet as a safety precaution before carrying out any type of cleaning or maintenance procedure.

Front Panel Cleaning Instructions

- The front of the display has been specially treated. Wipe the surface gently using only a cleaning cloth or a soft, lint-free cloth.
- If the surface becomes dirty, soak a soft, lint-free cloth in a mild detergent solution. Wring the cloth to remove excess liquid. Wipe the surface of the display to remove dirt. Then use a dry cloth of the same type to dry.
- Do not scratch or hit the surface of the panel with fingers or hard objects of any kind.
- Do not use volatile substances such as insert sprays, solvents and thinners.

Cabinet Cleaning Instructions

- If the cabinet becomes dirty, wipe the cabinet with a soft, dry cloth.
- If the cabinet is extremely dirty, soak a lint-free cloth in a mild detergent solution. Wring the cloth to remove as much moisture as possible. Wipe the cabinet. Use another dry cloth to wipe over until the surface is dry.
- Do not allow any water or detergent to come into contact with the surface of the display. If water or moisture gets inside the unit, operating problems, electrical and shock hazards may result.
- Do not scratch or hit the cabinet with fingers or hard objects of any kind.
- Do not use volatile substances such as insert sprays, solvents and thinners on the cabinet.
- Do not place anything made from rubber or PVC near the cabinet for any extended periods of time.

Troubleshooting

Symptom	Possible Cause	Remedy
No picture is displayed	<ol style="list-style-type: none"> 1. The power cord is disconnected. 2. The main power switch on the back of the display is not switched on. 3. The selected input has no connection. 4. The display is in standby mode. 	<ol style="list-style-type: none"> 1. Plug in the power cord. 2. Make sure the power switch is switched on. 3. Connect a signal connection to the display.
Interference displayed on the display or audible noise is heard	Caused by surrounding electrical appliances or fluorescent lights.	Move the display to another location to see if the interference is reduced.
Color is abnormal	The signal cable is not connected properly.	Make sure that the signal cable is attached firmly to the back of the display.
Picture is distorted with abnormal patterns	<ol style="list-style-type: none"> 1. The signal cable is not connected properly. 2. The input signal is beyond the capabilities of the display. 	<ol style="list-style-type: none"> 1. Make sure that the signal cable is attached firmly. 2. Check the video signal source to see if it is beyond the range of the display. Please verify its specifications with this display's specification section.
Display image doesn't fill up the full size of the screen	<ol style="list-style-type: none"> 1. The zoom mode is not set correctly. 2. Scan Mode may be set incorrectly to underscan. 3. If the image exceeds the screen size, Scan Mode may need to be set to Underscan. 	Use the Zoom mode or Custom zoom function in the Screen menu to fine tune display geometry and time frequency parameter.
Can hear sound, but no picture	Improperly connected source signal cable.	Make sure that both video inputs and sound inputs are correctly connected.
Can see picture but no sound is heard	<ol style="list-style-type: none"> 1. Improperly connected source signal cable. 2. Volume is turned all the way down. 3. Mute is turned on. 4. No external speaker connected. 	<ol style="list-style-type: none"> 1. Make sure that both video inputs and sound inputs are correctly connected. 2. Press + or - button to hear sound. 3. Switch MUTE off by using the  button. 4. Connect external speakers and adjust the volume to a suitable level.
Some picture elements do not light up	Some pixels of the display may not turn on.	This display is manufactured using an extremely high level of precision technology; however, sometimes some pixels of the display may not display. This is not a malfunction.

<p>After-Images can still be seen on the display after the display is powered off. (Examples of still pictures include logos, video games, computer images, and images displayed in 4:3 normal mode)</p>	<p>A still picture is displayed for an over extended period of time</p>	<p>Do not allow a still image to be displayed for an extended period of time as this can cause a permanent after-image to remain on the display.</p>
--	---	--

Technical Specifications

Item		Specifications		
		PL490	PL552	
Display	Screen Size (Active Area)		48.5" (123.2 cm) LCD	54.6" (138.7 cm) LCD
	Aspect Ratio		16:9	
	Number of pixels		1920 (H) x 1080 (V)	
	Pixel pitch		0.559 (H) x 0.559 (V) mm	0.630 (H) x 0.630 (V) mm
	Displayable colors		10 bits (D), 1.07 Billion colors	1.06B colors
	Brightness (typical)		450 cd/m ²	500 cd/m ²
	Contrast ratio (typical)		1300:1	1400:1
	Viewing angle		178 degrees	
In/Out Terminals	Speaker Output	Internal Speakers	10W (L) + 10W (R) RMS/8Ω	
		External Speakers	1 Way 1 Speaker System 82 dB/W/M/160 Hz ~ 13 KHz	
	Audio Output	3.5mm phone jack x 1	0.5V rms (Normal) / 2 Channel (L+R)	
	Audio Input	RCA Jack x 2	0.5V rms (Normal) / 2 Channel (L+R)	
		3.5mm phone jack x 1		
	RS232C	2.5mm Phone jack x 2	RS232C in/RS232C out	
	RJ-45	RJ-45 Jack x 1 (8 pin)	10/100 LAN Port	
	HDMI Input	HDMI Jack x 2 (Type A) (18 pin)	Digital RGB: TMDS (Video + Audio)	
			MAX: Video - 720p, 1080p, 1920 x 1080/60 Hz (WUXGA) Audio - 48 KHz/ 2 Channel (L+R) Supports LPCM only	
	DVI-D Input	DVI-D jack	Digital RGB: TMDS (Video)	
	VGA Input	D-Sub Jack x 1 (15 pin)	Analog RGB: 0.7V p-p (75Ω), H/CS/V: TTL (2.2kΩ), SOG: 1V p-p (75Ω)	
			MAX: 720p, 1080p, 1920 x 1080/60 Hz (WUXGA) Digital RGB: TMDS (Video)	
DVI-I (DVI-D & VGA) Output	DVI-I Jack x 1 (29 pin)	Analog RGB: 0.7V p-p (75Ω), H/CS/V: TTL (2.2kΩ), SOG: 1V p-p (75Ω)		
		MAX: 720p, 1080p, 1920 x 1080/60 Hz (WUXGA)		
Component Input	BNC Jack x 3	Y: 1V p-p (75Ω), Pb: 0.7V p-p (75Ω), Pr: 0.7V p-p (75Ω) MAX: 480i, 576i, 480p, 576p, 720p, 1080i, 1080p		
Video Input	BNC x 1 (Share with Component_Y)	Composite 1V p-p (75Ω)		

In/Out Terminals	Displayport in/out	Displayport Jack x 2 (20 pin)	Digital RGB: TMDS (Video + Audio) MAX: Video - 720p, 1080p, 1920 x 1080/60 Hz (WUXGA) Audio - 48 KHz/ 2 Channel (L+R) Supports LPCM only	
	Power Input / Power Supply		100 - 240V~, 50 - 60Hz, 3.5A	AC 100 - 240V, 50 - 60Hz, 3.5A
General	Power Consumption (Max)		235 W	350 W
	Power Consumption (typ.)		110 W	185 W
	Power Consumption (Standby & Off)		<0.5 W (RS232 in active)	
	Dimensions (Without Stand) W x H x D (cm)		1077.7 x 607.8 x 93.5 (@ Wall mount) / 103.8 (@ Handle)	1213.4 x 684.2 x 95.0 (@ Wall Mount)/103.4 (@ Handle)
	Weight (Without Stand)		21.6 Kg	29.2 Kg
	Gross Weight (Without Stand)		33.3 Kg	43.5 Kg
	Environmental Condition	Temperature	Operational	0 ~ 40°C
Storage			-20 ~ 60°C	
Humidity		Operational	20 ~ 80% RH (No condensation)	
		Storage	5 ~ 95% RH (No condensation)	
Altitude		Operational	0 ~ 3,000 m	0 ~ 5,000 m
		Storage / Shipment	0 ~ 9,000 m	
Internal Speaker	Type		1 Way 1 Speaker	
	Input		10 W (RMS)	
	Impedance		8Ω	
	Output Sound Pressure		82 dB/W/M	
	Frequency Response		160 Hz ~ 13 KHz	